

THE POWER OF

REDARC®

BCDC® Core

Dual Input Multi-Stage
In-Cabin Battery Charger

MODELS:

- **BCDCN1225**
25 A CHARGER
- **BCDCN1240**
40 A CHARGER

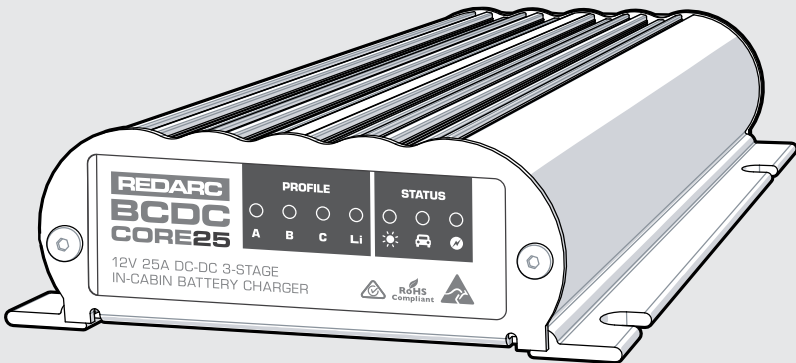

BCDCN1225 & BCDCN1240

Dual Input Multi-Stage In-Cabin Battery Charger

The BCDC Core Battery Chargers are designed to keep your vehicles auxiliary battery system fully charged and can source power from 12V or 24V vehicle alternators and 12V solar panels.

Designed around REDARCs tried and tested charging technology, the Core 25 and Core 40 features a DC-DC charger, an MPPT solar regulator and a smart battery isolator all packed into one compact, lightweight unit suitable for in-cabin installations.

Using this proven combination, the BCDC Core fully charges all common types of 12V automotive lead acid or LiFePO_4 lithium auxiliary batteries while protecting your vehicles start battery from excessive discharge.

CONTENTS

- WARNINGS AND SAFETY INSTRUCTIONS 4**

- 1 PRODUCT OVERVIEW 6**
 - 1.1 Cables and Wires 7
 - 1.2 Charge Profile LEDs 7
 - 1.3 Charge Status LEDs 8

- 2 PRODUCT FUNCTION 9**
 - 2.1 Charging Stages 9
 - 2.2 Battery Test Mode 10
 - 2.3 Green Power Priority 10

- 3 INSTALLATION 11**
 - 3.1 Planning Installation 11
 - 3.2 Installation Overview 12
 - 3.3 Cable sizing 14
 - 3.4 Cable Connections 15
 - 3.5 Fusing 18
 - 3.6 Mounting 19
 - 3.7 Cable and Wire Installations 19
 - 3.8 Maintenance 25

- 4 TROUBLESHOOTING 26**
 - 4.1 Error Codes 28
 - 4.2 Turn On/Off Thresholds 29

- 5 FREQUENTLY ASKED QUESTIONS 30**

- 6 SPECIFICATIONS 32**

- WARRANTY 33**

WARNINGS AND SAFETY INSTRUCTIONS

SAVE THESE INSTRUCTIONS — This manual contains important safety instructions for the BCDCN1225 / BCDCN1240 Battery Charger.

Do not operate the BCDC Core unless you have read and understood this manual and the charger is installed as per these installation instructions. REDARC recommends that the charger be installed by a suitably qualified person.

⚠ WARNING

RISK OF EXPLOSIVE GASES: Working in vicinity of a Lead-Acid battery is dangerous. Batteries generate explosive gases during normal operation. For this reason, it is of utmost importance that you follow the instructions when installing and using the charger.

SAFETY MESSAGE CONVENTIONS

Safety messages in this manual include a signal word to indicate the level of the hazard as follows:

⚠ WARNING

Indicates a potentially hazardous situation which, if not avoided, **could result in death or serious injury to the operator or to bystanders.** Carefully read the message and follow instructions precisely.

⚠ CAUTION

Indicates a potentially hazardous situation which, if not avoided, **may result in moderate or minor injury to the operator or to bystanders.** Read the message and follow instructions precisely.

NOTICE

Indicates a situation that **may cause equipment damage.**

⚠ CAUTION

- 1.** The BCDC Core should not be used by persons (including children) with reduced physical, sensory or mental capabilities, or lack of experience and knowledge, unless they are supervised or have been instructed on how to use the appliance by a person responsible for their safety. Children should be supervised to ensure that they do not play with the Battery Charger.
- 2.** Do NOT alter or disassemble the BCDC Core under any circumstances. All faulty units must be returned to REDARC for repair. Incorrect handling or reassembly may result in a risk of electric shock or fire and may void the unit warranty.
- 3.** Only use the BCDC Core for charging Standard Automotive Lead Acid, Calcium Content, Gel, AGM, SLI, Deep Cycle or Lithium Iron Phosphate type 12V batteries.
- 4.** Check the manufacturer's data for your battery and ensure that the 'Maximum' voltage of the profile you select does not exceed the manufacturer's recommended maximum charging voltage. If the 'Maximum' voltage is too high for your battery type, please select another charging profile.
- 5.** Check the manufacturer's data for your battery and ensure that the 'Continuous Current Rating' of the charger does not exceed the manufacturer's recommended maximum charging current.
- 6.** When using the BCDC Core to charge a Lithium Iron Phosphate battery, only batteries that feature an inbuilt battery management system featuring under and over voltage protection and cell balancing are suitable.
- 7.** The BCDC Core is not intended to supply power to a low voltage electrical system other than to charge a battery.
- 8.** Cable and fuse sizes are specified by various codes and standards which depend on the type of vehicle the BCDC Core is installed into. Selecting the wrong cable or fuse size could result in harm to the installer or user and/or damage to the BCDC Core or other equipment installed in the system. The installer is responsible for ensuring that the correct cable and fuse sizes are used when installing this Battery Charger.
- 9.** NEVER smoke or allow a spark or flame in vicinity of battery or engine. This may cause the battery to explode.

PERSONAL SAFETY PRECAUTIONS

- 10.** To assist with the safe operation and use of the BCDC Core when connected to the battery:
 - a.** Wear complete eye protection and clothing protection. Avoid touching eyes while working near a battery.
 - b.** If battery acid contacts your skin or clothing, remove the affected clothing and wash the affected area of your skin immediately with soap and water. If battery acid enters your eye, immediately flood the eye with running cold water for at least 10 minutes and seek medical assistance immediately.



1 PRODUCT OVERVIEW

The BCDC Core 25 and BCDC Core 40 are three-stage, DC-DC 12V auxiliary battery chargers that source power from both the vehicles alternator and solar panel input. The BCDC Core's vehicle input is suitable for 12V or 24V start battery and alternator systems while the solar input is designed for connection to unregulated 12V nominal solar panels. As a true dual input charger with an in-built MPPT regulator, the unit charges simultaneously from solar and alternator with Green Power Priority to minimise load on the vehicle alternator.

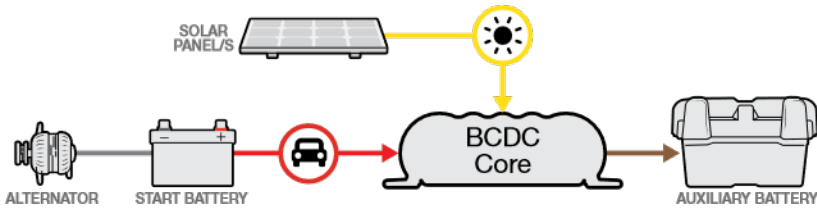

The BCDC Core compensates for the input voltage of either power source, always outputting the ideal voltage to charge the selected battery type. This capability makes it ideal for charging a wide variety of auxiliary 12V batteries including Lithium batteries and overcomes voltage drop over long cable runs.

In addition, BCDC Core features an internal battery isolator that disconnects the auxiliary battery system from the start battery based on voltage. This allows the charger to safely charge the auxiliary battery from the vehicle and prevents the start battery from being excessively discharged.

All these features are combined in a compact, lightweight housing to suit mounting within vehicle cabins and battery boxes.

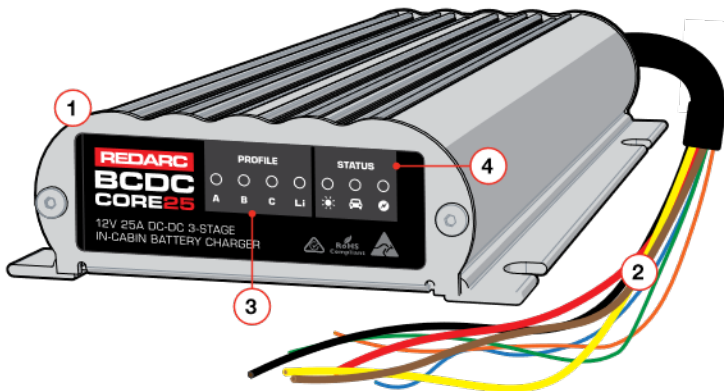

1. BCDC Core

2. Wires

See section "1.1 Cables and Wires" (page 7) for wiring information.

3. Profile LEDs

Displays the charge profile of the BCDC

4. Status LEDs







Displays the charge status of the BCDC

1.1 Cables and Wires

The BCDC Core Battery Chargers are equipped with a fly lead wiring harness that must be correctly connected to ensure effective charging of the auxiliary battery. See "Table 1.1.1: Wire Description" for more information.

Refer to "3.2.1 Battery Setup" (page 12) and "3.7 Cable and Wire Installations" (page 19) for typical BCDC Core Battery Charger setups and wire installation details.

Table 1.1.1: Wire Description

Wire Colour	Description	Length	Gauge	Purpose
 Brown	Output Cable	392 mm / 15.4"	8 mm ² / 8AWG	Connects to the auxiliary battery
 Black	Ground Cable	424 mm / 16.7"	8 mm ² / 8AWG	Connects to the common ground
 Orange	Profile Selection Wire	447 mm / 17.6"	0.5 mm ² / 20AWG	Used to configure the Charge Profile.
 Red	Vehicle Input Cable	457 mm / 18"	8 mm ² / 8AWG	Connects to the vehicles start battery positive terminal.
 Blue	Vehicle Ignition Wire	479 mm / 18.9"	0.5 mm ² / 20AWG	Connects to ignition signal for vehicles with Smart Alternators
 Yellow	Solar Input Cable	507 mm / 20"	8 mm ² / 8AWG	Connects to the solar panel input positive
 Green	External LED Wire	484 mm / 19"	0.5 mm ² / 20AWG	Used to power optional LED / connects to Orange Wire for Lithium batteries.

1.2 Charge Profile LEDs

The Dual Input In-cabin BCDC Core features four different charging profiles designed to suit your battery's charging requirements. The BCDC Core supports AGM/Gel (**A**), Standard Lead Acid (**B**), Calcium (**C**) and Lithium (**Li**) profiled batteries. Refer to the charging specifications stated by the battery manufacturer, and the installation temperature chart before selecting the profile for your installation (see "Table 3.7.3.1: Charge Profile Selection for Cabin Installation" (page 20)).

Profile LED

- A.** AGM/Gel **C.** Calcium
- B.** Lead Acid **Li.** Lithium

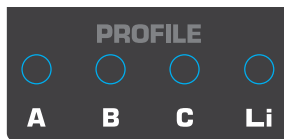



The selected Profile LED will be on solid when the unit is ON and charging. A flashing profile LED indicates that the unit is in standby mode and ready to charge when the vehicle is turned on.

1.3 Charge Status LEDs

The Charge Status LEDs indicate to the user which inputs are available and what stage of the charge process the unit is currently in.

Status LED

-  Solar
-  Vehicle
-  Stage

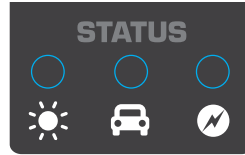

1.3.1 SOLAR & VEHICLE LEDS





The Solar and Vehicle LEDs will be ON when the input is available and in use and OFF when the input is not available or not in use. If the LEDs are flashing refer to ["4.1 Error Codes" on page 28](#).

1.3.2 STAGE LED

The Stage LED indicates the Charge Profile Stage. With any profile selected the charger will output a 3-Stage charging profile with Boost, Absorption and Float Stages.

["Table 1.3.2.1: Charge Stage LED Sequences"](#) outlines the LED sequences which indicate these stages and ["Figure 2.1.2.1: Charging Stages"](#) on page 9 explains the Charging Process.

Table 1.3.2.1: Charge Stage LED Sequences

LED Flash Sequence	Profile Stage
Off 	OFF / No Output
Continuous 	Boost (Constant Current)
2 Seconds 	Absorption (Constant Voltage)
2 Seconds 	Float

2 PRODUCT FUNCTION

2.1 Charging Stages

BOOST

When the Battery Charger is correctly installed and has a valid power input source it will begin charging the auxiliary battery in the Boost stage. The Boost stage maintains a constant current until the battery voltage reaches its Absorption Voltage. The current in Boost stage may vary during operation in order to maintain safe operating temperature, or to limit the difference between input and output voltages.

ABSORPTION

The Charger will then move to Absorption stage which maintains a constant voltage level for a preset period of time or until the current being drawn by the output battery drops to a predetermined level for 30 seconds; after which the Charger will enter Float stage.

FLOAT

Float stage maintains 13.3V (13.6V for LiFePO₄) on the output battery, keeping the battery topped up. This counteracts the battery's self discharging or loads applied to the battery. When the battery loses charge, the Battery Charger will move back into the Boost stage.

Figure 2.1.2.1: Charging Stages

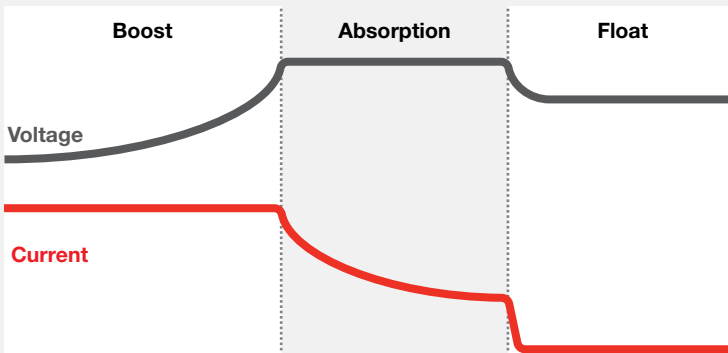

The BCDC has automatic timeouts to protect the battery from being damaged by overcharging. The BCDC will automatically move from Boost to Absorption or Float according to these timeouts. If a timeout occurs before the battery is fully charged, the charge process will begin again from the Boost stage after a brief 'rest-period'. The Li profile timeouts have been designed to suit optimal charging for large lithium battery banks.

⚠ CAUTION

When using the BCDC Core to charge a Lithium Iron Phosphate battery, only batteries that feature an inbuilt battery management system featuring under and over voltage protection and cell balancing are suitable.

2.2 Battery Test Mode

The Battery Charger enters a battery test mode every 100 seconds to check that the input being received from either solar or vehicle battery is still valid and that the auxiliary battery is still correctly connected to the output. This feature protects the vehicle start battery from over discharge as well as protecting the vehicle and its wiring in the event of damage to the output connection.

2.3 Green Power Priority

Green Power Priority is an automatic function that defines the order that input sources are prioritised. This ensures that your battery will always take as much power as possible from solar panels before supplementing from other sources. This lightens the load on your vehicle alternator and maximises the collection of free solar energy.

Charging source priority is given in the following order:

1. Solar (unregulated, 12V solar panel)
2. Alternator (via the Start Battery while the vehicle is running)

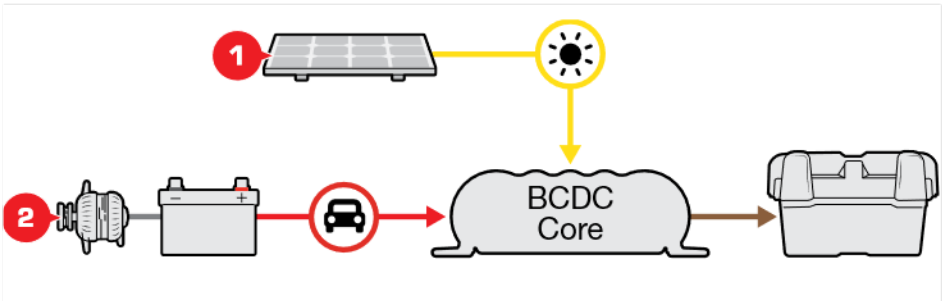

3 INSTALLATION

3.1 Planning Installation

⚠ CAUTION

The heatsink can reach around 60°C/140°F (this is normal and safe operation when the unit deliver full power or run in hot conditions). The location to install the unit should prevent contact with the users of the vehicle and not be in contact with highly flammable material.

3.1.1 MOUNTING LOCATION

The BCDC Core Battery Charger is designed for installation within the vehicles cabin or in a similarly protected environment such as in a ute canopy, caravan or battery box. The unit will operate optimally below 55°C/130°F with good airflow. At higher temperatures the unit will de-rate output current up to 80°C/175°F at which point the unit will turn OFF.

IMPORTANT: The BCDC Core must not be mounted in the engine bay of a vehicle. Moisture ingress and heat build up may damage the Battery Charger.

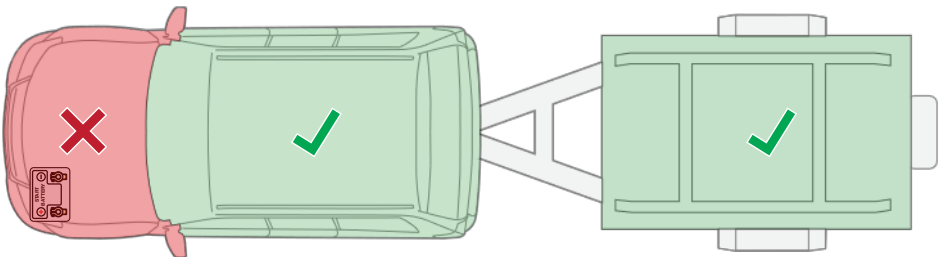

The Battery Charger should be mounted as close as possible to the auxiliary battery, with no more than 1 m of cable length from the unit to the auxiliary battery. Assess a suitable mounting position for the auxiliary battery and Battery Charger before planning out cables and connections.

REDARC recommend ensuring the LED indicators on the Battery Charger can be accessed and are visible for troubleshooting (see "4.2 Turn On/Off Thresholds" on page 29).

3.2 Installation Overview

"Figure 3.2.1.1: Typical Battery Setup" provides a generic overview of the BCDC Core's interfaces with the components recommended to charge an auxiliary battery. Refer to "Figure 3.2.1.1: Typical Battery Setup" to plan the required cabling, fusing and connections needed for your installation.

REDARC recommends that the Battery Charger be installed by a suitably qualified person.

3.2.1 BATTERY SETUP

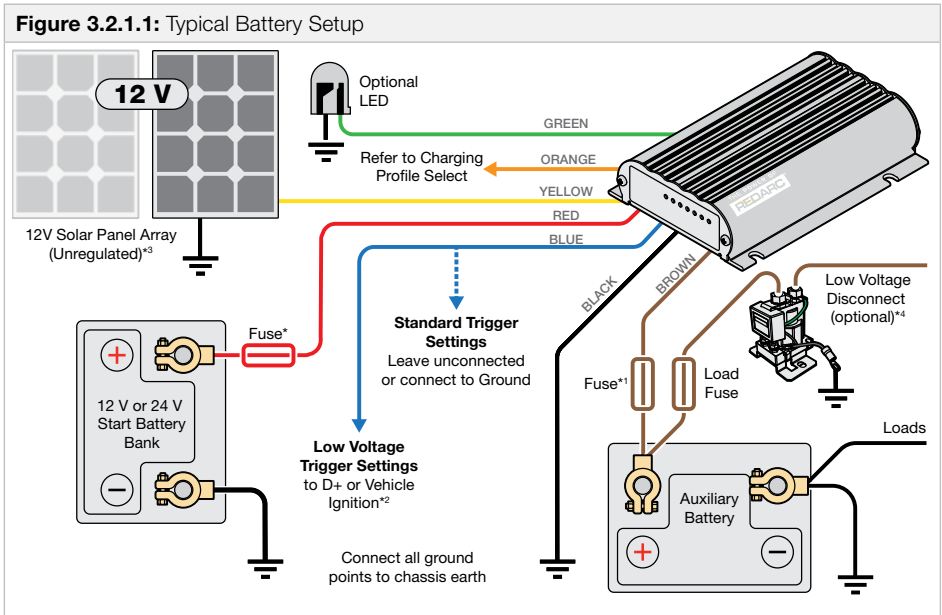

*1 Fuse Ratings to be as per the table in "Table 3.5.1: Fuse Rating" (page 18).

*2 To connect the Blue wire to the vehicle's ignition, connect the Blue wire to an ignition switched fuse in one of the vehicles fuse boxes, located in either the engine compartment or vehicle cabin.

*3 Do not connect regulated solar panels. If solar is not connected, tape over unused wires.

*4 The SBI-12LLD Low Voltage Disconnect is an optional component used to protect the auxiliary damage from excessive discharge.

3.2.2 CONSIDERATIONS PRIOR TO INSTALLATION

- 1. Auxiliary Battery Profile Selection** — Determine the chemistry of your auxiliary battery prior to install as this will influence the connection of the **ORANGE** wire that is used to set the charge profile of the BCDC Core (see "3.7.3 Profile Selection — Orange Wire" (page 20)).
- 2. Fixed or Removable** — Determine if your install requires connections to be permanent or easily disconnected. This influences the connector choice as soldered butt splice connectors are more suitable for fixed wiring while Anderson plugs are more suitable when disconnection is required, such as with portable battery boxes, trailers and portable solar panels (see "3.4 Cable Connections" (page 15)).
- 3. Solar Panel Selection** — Consider if your auxiliary battery system will have permanently wired solar panels connected or portable panels such as a solar blanket. This influences wiring and connector choice. Ensure the panel is 12V nominal and does not have a built in solar regulator.
- 4. Vehicle Alternator Type** — Determine if your vehicle has a variable-voltage or idle-stop alternator (smart alternator) these types of alternators require the **BLUE** wire connection for the BCDC Core to function correctly (see "3.7.5 Vehicle Ignition Input — Blue Wire" (page 22)).

Smart alternators are common on vehicles manufactured from 2015 onwards that are compliant with Euro 6 emissions regulations. Determine if your vehicle has a smart alternator by checking for a battery sensor on your vehicles start battery as illustrated in "Figure 3.2.2.1: Standard Alternator vs Variable Voltage Alternator" (page 13). Older vehicles or other models with fixed voltage or temperature compensating alternators do not require the **BLUE** wire connection.

Figure 3.2.2.1: Standard Alternator vs Variable Voltage Alternator

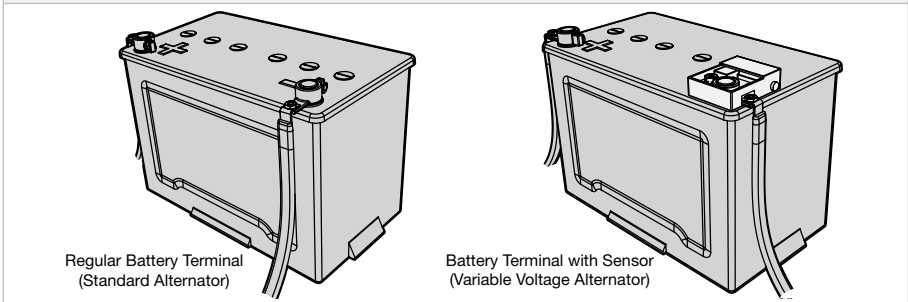

- 5. Cable Length and Gauge** — Determine the length of cable required to connect BCDC Core to the vehicle start battery and solar panels in your application. This influences the gauge of wire required. See "3.3 Cable sizing" (page 14) to determine appropriate cable gauge suitable for your installation. Note that B&S (Brown & Sharpe), AWG (American Wiring Gauge), GA (Gauge) are interchangeable terms for measuring wiring diameter (e.g 8 B&S = 8 AWG = 8 GA)
- 6. Common Ground** — Before planning wiring, consider that the BCDC Core, auxiliary battery, start battery and solar panel/s must all share a common electrical ground to correctly charge from both inputs. This is typically achieved by connecting all grounds to the vehicle body.
- 7. Auxiliary Battery Load Current** — Before wiring the auxiliary battery system, determine the loads to be powered and the total current to be drawn from the battery. This affects the load cable gauge and load fuse rating.

3.2.3 WHAT YOU WILL NEED

TOOLS

In the following sections of this manual, guidance is given on the installation of the BCDC Core which may require common automotive electrical tools such as:

- Screwdriver set
- Spanner set
- Socket set
- Pliers
- Side cutters
- Cable cutters
- Ratcheting or Hydraulic crimping tool
- Soldering Iron

CONSUMABLES

To mount, connect and manage wiring of the BCDC Core Battery Charger, installers use a range of materials including:

- Cabling
- Cable connectors, lugs and terminals
- Fuses
- Electrical tape
- Heat Shrink
- Cable ties
- Conduit/Split tubing
- Wires
- Fasteners

Depending on your setup, additional fixings (nuts, bolts and self-tapping screws) and battery post clamps may be required.

3.3 Cable sizing

The heavy gauge cables on BCDC Core 25 and Core 40 carry peak currents of up to 35/55 A respectively. To carry this current effectively, the wire gauge required when extending this cables depends on the length of cable run required.

Refer to "[Table 3.3.1: Cable and Lug Sizing](#)" (page 14) for cable thickness requirements for the following cables:

- **Brown*** Output Cable
- **Black** Ground Cable
- **Red** Vehicle Input Cable
- **Yellow** Solar Input Cable

***NOTE:** The Brown Output cable should be at maximum 1m in length.

Before making any connections run and layout the cables and wires required for your setup; trim any excess if needed using side or cable cutters.

Part Number	Cable Install Length		Cross Sectional Area	Nearest Equivalent B&S, BAE, AWG	Lug Cable Size
BCDCN1225	1 – 5 m	3' – 16'	≥ 7.7 mm ²	8	8B&S/10 mm ²
	5 – 9 m	16' – 30'	≥ 13.6 mm ²	6	6B&S/16 mm ²
BCDCN1240	1 – 5 m	3' – 16'	≥ 13.6 mm ²	6	6B&S/16 mm ²
	5 – 9 m	16' – 30'	≥ 20.3 mm ²	4	4B&S/25 mm ²

⚠ CAUTION

Cable and fuse sizes are specified by various codes and standards which depend on the type of vehicle the BCDC Core is installed into. Selecting the wrong cable or fuse size could result in harm to the installer or user and/or damage to the BCDC Core or other equipment installed in the system. The installer is responsible for ensuring that the correct cable and fuse sizes are used when installing this Battery Charger.

Cabling is recommended to be away from heat sources and in protected areas, especially when installing.

3.4 Cable Connections

The BCDC Core's heavy gauge cables require good, low resistance electrical connections that will not degrade over time.

⚠ CAUTION

Failure to make a good reliable connection may result in breakdown of the wire insulation and cause a short circuit, or worst case a fire. REDARC recommend this activity be undertaken by an appropriately trained person.

For extending the cables provided on the BCDC Core, REDARC recommends using a soldered butt-splice crimp connection that is covered with heat shrink (see "[Figure 3.4.1: Crimping using Butt-Splices](#)" (page 15)).

Crimping provides good mechanical connection, soldering provides a long lasting electrical connection and forming of the heat shrink is designed to prevent from any shorting/contact with your vehicle chassis.

Figure 3.4.1: Crimping using Butt-Splices

1. Slide heatshrink over wire then insert wires into butt-splice. Keep heatshrink away from joint until after soldering is complete and has cooled.

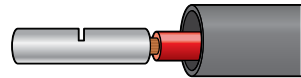

2. Crimp both wires to the butt-splice using single-indent type crimpers.

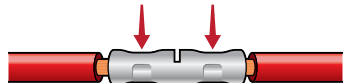

3. Solder the wires to the butt-splice. Ensure that a good connection is made.

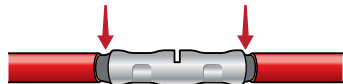

4. Wait for the butt-splice to cool, then slip heatshrink over the point and heat.



LUG CONNECTIONS

Cable lugs are commonly used when connecting cables between components of the auxiliary battery system.

See "Table 3.3.1: Cable and Lug Sizing" (page 14) for appropriate lug sizes in mm² to suit common B&S cable gauges used in auxiliary battery installations.

For a secure connection, strip back the cable roughly 12 mm—14 mm and fit the cable into the lug, then crimp the lug down to secure the cable.

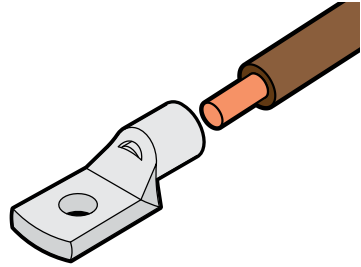

Do not use standard pre-insulated Red/Blue/Yellow crimp connectors for connection of the BCDC Core's 8 B&S cables as they are not rated to carry the required current.

REDARC fuse kits FK40 and FK60 include 4 × 10mm² (8 B&S) crimp lugs that allow connection of the Vehicle Input and Output cables to the MIDI fuse holders in the kit.

For cables that require disconnection, such as when using a portable battery box or portable solar panels, Anderson™ SB50 connectors may be used. These connectors are commonly used where the Battery Charger and auxiliary battery is mounted in a battery box or in a trailer where it must be easily disconnected from the vehicle.

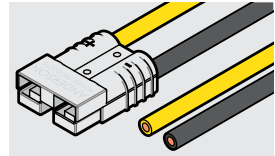

To ensure a secure connection into the Anderson plug contacts, cables smaller than 8 B&S may need the exposed wire folded over on itself for a snug fit in the contact before crimping.

When crimping any of these connector types, REDARC recommends using a ratcheting or hydraulic crimp tool as well as using heat shrink to prevent and shorting/contact with other components.

Figure 3.4.2: Typical Cable Connectors — Portable Auxiliary Battery System

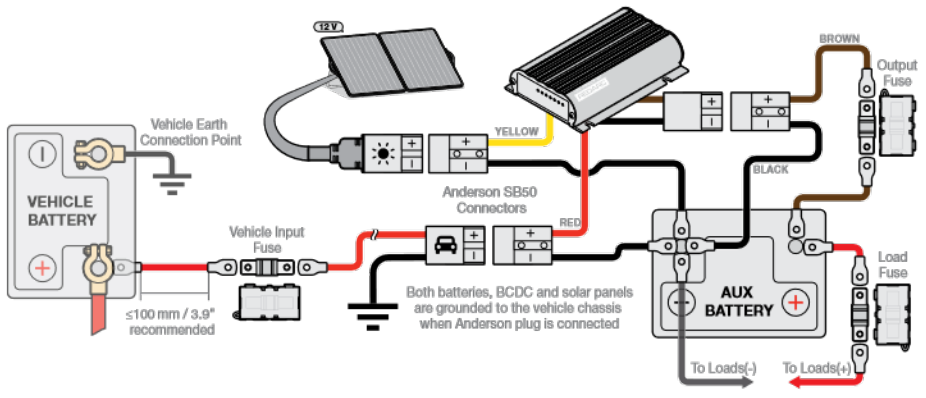
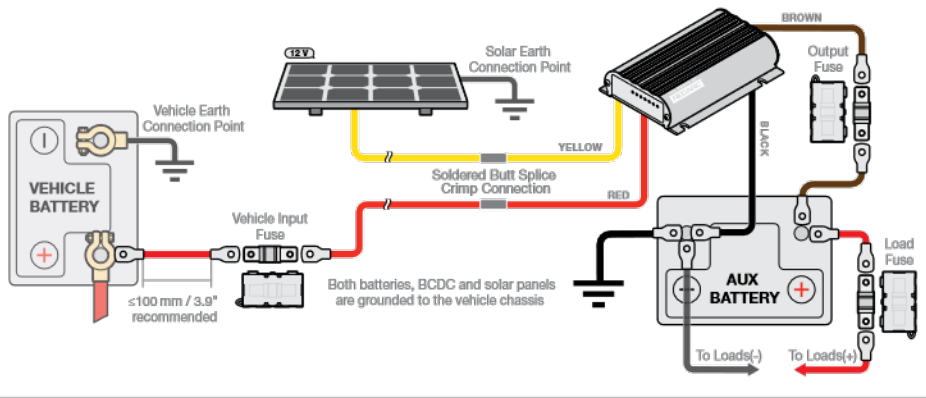

Figure 3.4.3: Typical Cable Connectors — Fixed Auxiliary Battery System



3.5 Fusing

As illustrated in "Figure 3.2.1.1: Typical Battery Setup" (page 12) fuses are required to protect the **RED** Vehicle Input cable and the **BROWN** Output cable. REDARC recommends the **RED** cable fuse to be mounted within 100 mm cable length from the vehicle start battery positive terminal. The **BROWN** Output cable fuse should be mounted within 100 mm cable length from the auxiliary battery positive terminal. Refer to "Table 3.5.1: Fuse Rating" (page 18) for the appropriate fuse sizing for each Battery Charger variant.

Table 3.5.1: Fuse Rating			
Charger Model	Charger Current Rating	Vehicle Input and Output Fuse Ratings	Recommended Fuse Kit
BCDCN1225	35 A	40 A	FK40
BCDCN240	55 A	60 A	FK60

REDARC recommends using MIDI style bolt down fuses as they ensure a low resistance connection. Blade type fuses are not recommended as they can result in a high resistance connection which causes excess heat and may damage the fuse holder and/or the wiring.

Self-resetting circuit breakers are not recommended as they may trip prematurely due to the heat generated by the current flowing through the cables.

When installing MIDI Fuses, ensure that the nuts securing the fuse and cable lug are tightened all the way down to avoid high resistance connections (see "Figure 3.5.2: MIDI Style Bolt-Down Fuse").

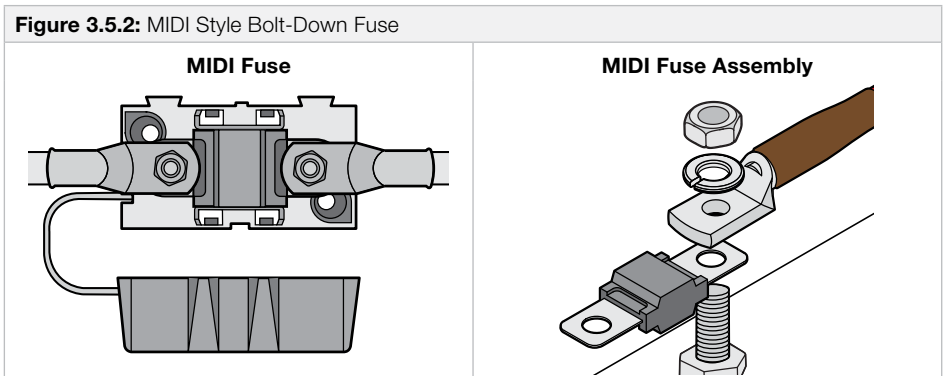

3.6 Mounting

⚠ WARNING

Use suitable Personal Protective Equipment when operating power tools.



Ensure the mounting location is structural enough to support the BCDC and its cabling.

Use 4 × M6 or similar sized fasteners to firmly secure the BCDC Core in its mounting location.

Check the LED indicators on the Battery Charger can be accessed and are visible for troubleshooting (see "4.2 Turn On/Off Thresholds" (page 29)).

Figure 3.6.1: Mounting the Charger

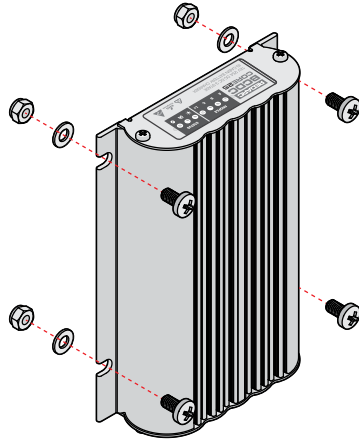

3.7 Cable and Wire Installations

NOTE: Damage to cabling can cause failure of the BCDC and vehicle electrical systems. Ensure cabling is clear of sharp edges or moving parts, and have enough slack to allow for flexing. REDARC recommend using cable ties and conduit or split tubing to manage cabling.

3.7.1 OUTPUT AUXILIARY BATTERY – BROWN CABLE

The **BROWN** cable is used to connect the BCDC Core to the auxiliary battery.

Connect the **BROWN** cable to the MIDI fuse prior to connecting to the positive terminal of the auxiliary battery. Ensure the cable length is at maximum 1m from the Battery Charger and the MIDI fuse is mounted in close proximity of the auxiliary battery (see "Figure 3.5.2: MIDI Style Bolt-Down Fuse" (page 18)). See "Table 3.5.1: Fuse Rating" (page 18) for appropriate size fuses.

Figure 3.7.1.1: Connecting the **BROWN** Cable

Auxiliary Battery Input

Connect the **BROWN** cable to the positive terminal of the battery.

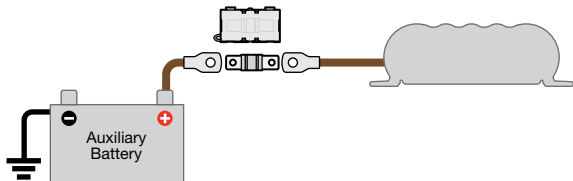

3.7.2 COMMON GROUND — BLACK CABLE

The **BLACK** wire must be connected to a ground point that forms a common ground with both the start battery and the auxiliary battery. Most commonly the vehicle electrical systems ground/earth reference is the metal of the bodywork. See "Figure 3.4.2: Typical Cable Connectors — Portable Auxiliary Battery System" (page 17) and "Figure 3.4.3: Typical Cable Connectors — Fixed Auxiliary Battery System" (page 17) for illustrations of how this may be achieved.

Figure 3.7.2.1: Connecting the **BLACK** cable

Common Ground Connection

Connect the **BLACK** wire to a ground point that is common with the start and auxiliary battery.

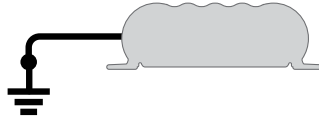

3.7.3 PROFILE SELECTION — ORANGE WIRE

Connect the **ORANGE** wire to set the maximum output voltage to suit your selected Charge Profile. If required to leave the **ORANGE** wire disconnected tape over the end of the wire.

Refer to "Table 3.7.3.1: Charge Profile Selection for Cabin Installation" to select the correct profile for your installation configuration.

Table 3.7.3.1: Charge Profile Selection for Cabin Installation

Battery Type	Charge Profile (25°C / 75°F)	Maximum Battery Voltage Specification
AGM/Gel	A	14.6
Standard Lead Acid	B	15.0
Calcium	C	15.3
Lithium	Li	14.5 (LiFePO ₄)

⚠ CAUTION

Check the manufacturer's data for your battery and ensure that the Maximum voltage of the Charging Profile you select does not exceed the manufacturer's recommended maximum charging voltage. If the Maximum voltage is too high for your battery type, select another Charging Profile.

Figure 3.7.3.2: Setting the Maximum Voltage (ORANGE wire)

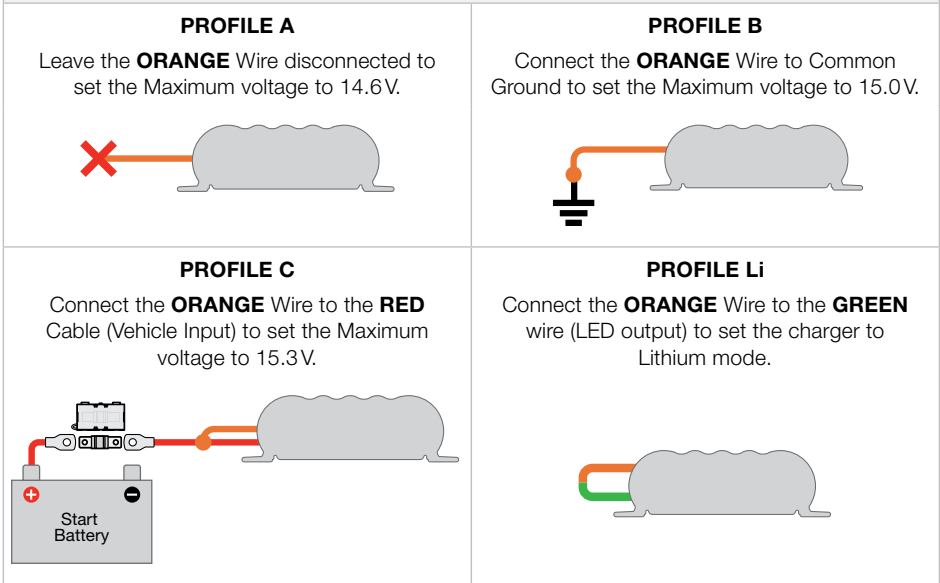

3.7.4 VEHICLE INPUT – RED CABLE

The **RED** cable is used to connect the BCDC to the vehicles start battery.

Connect the **RED** cable to the MIDI fuse prior to connecting to the positive terminal of the start battery. Ensure the MIDI fuse is mounted within 100mm of cable length from the start battery (see "[Figure 3.5.2: MIDI Style Bolt-Down Fuse](#)" (page 18)).

See "[Table 3.5.1: Fuse Rating](#)" (page 18) for appropriate size fuses.

Figure 3.7.4.1: Connecting the **RED** cable

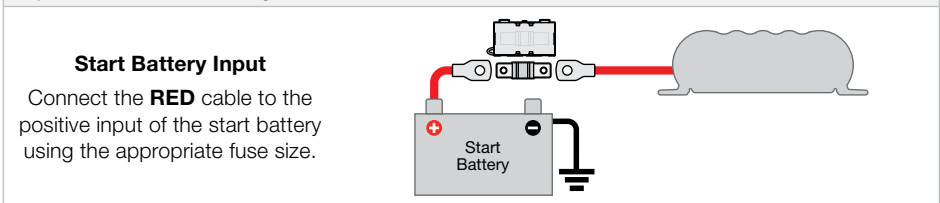

3.7.5 VEHICLE IGNITION INPUT – BLUE WIRE

The **BLUE** wire is required for the BCDC Core to operate in Low Voltage mode when installed in vehicles with variable-voltage alternators.

If required to leave the **BLUE** wire disconnected, apply electrical tape over the end of the wire.

Figure 3.7.5.1: Connecting the **BLUE** wire

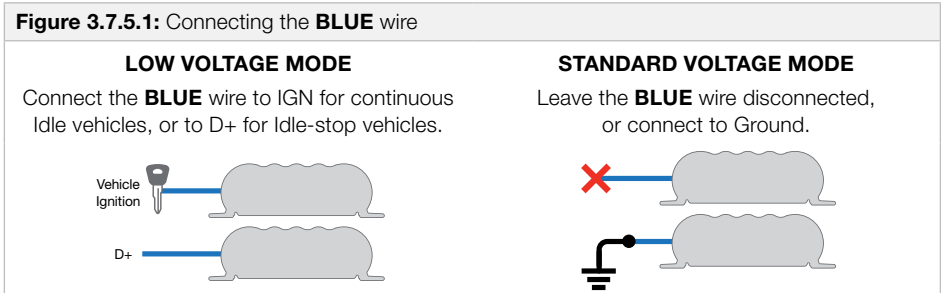

LOW VOLTAGE MODE

Modern vehicle electrical systems use variable voltage alternators that output a wider range of voltages. To improve auxiliary battery charging, the BCDC incorporates a 'Low Voltage Mode' which increases the voltage range the auxiliary battery charging takes place. To enable this mode, connect the **BLUE** wire to a signal which is active when the engine is running. For most vehicles the 'Ignition ON' signal is sufficient. A suitable signal source is commonly found in the vehicle's engine bay or cabin fuse box.

For vehicles equipped with 'Idle-Stop' or 'Stop-Start', connect the **BLUE** wire to the 'D+' signal (contact your vehicle dealer for details).

On vehicles operating with smart alternator or 'Idle-Stop' technology, leaving the **BLUE** wire disconnected may lead to extended times where the Auxiliary Battery may not charge even when the engine is running.

STANDARD VOLTAGE MODE

For vehicles with fixed voltage alternators or temperature compensating alternators, attaching the **BLUE** wire is not required and the BCDC will charge effectively in Standard Mode.

The output voltage from these alternator will remain above the "Standard" BCDC turn off threshold during normal driving. Without the **BLUE** wire attached, the BCDC will measure start battery voltage via the **RED** wire and charge when it is within the "Standard" voltage thresholds (see "4.2 Turn On/Off Thresholds" (page 29)).

Table 3.7.5.2: Input Mode Charging Thresholds

Mode	Blue Wire Connection	12V Input Thresholds		24V Input Thresholds	
		ON above	OFF below	ON above	OFF below
Low Voltage	D+ for Idle-Stop 'Ignition' for others	12.0V	11.9V	24.0V	23.8V
Standard	Not Connected, or Connected to Ground	12.9V	12.7V	25.8V	25.4V

BLUE WIRE INSTALLATION USING A RELAY

An ignition switched relay can be used in situations where an ignition signal, the **BLUE** wire, is required but it is difficult to run an ignition feed all the way to the BCDC (e.g. when installed in a trailer or battery box).

A relay can be added on the Vehicle Input (**RED** cable) of the BCDC and controlled by a vehicle ignition signal. This can provide a Vehicle Input feed that is only on when the ignition is on. Connecting the **BLUE** wire to the BCDC Core's **RED** wire will enable the Battery Charger to charge the auxiliary battery in 'Low Voltage Mode' (see "Figure 3.7.5.3: Installation Using a Relay").

For 12V applications, REDARC recommends the RK1260 Relay Kit that includes all components required including heat shrink, relay holder and butt-splice connectors. Alternatively the installer can source any high quality relay that meets or exceeds the current rating of the Vehicle Input Fuse.

Figure 3.7.5.3: Installation Using a Relay

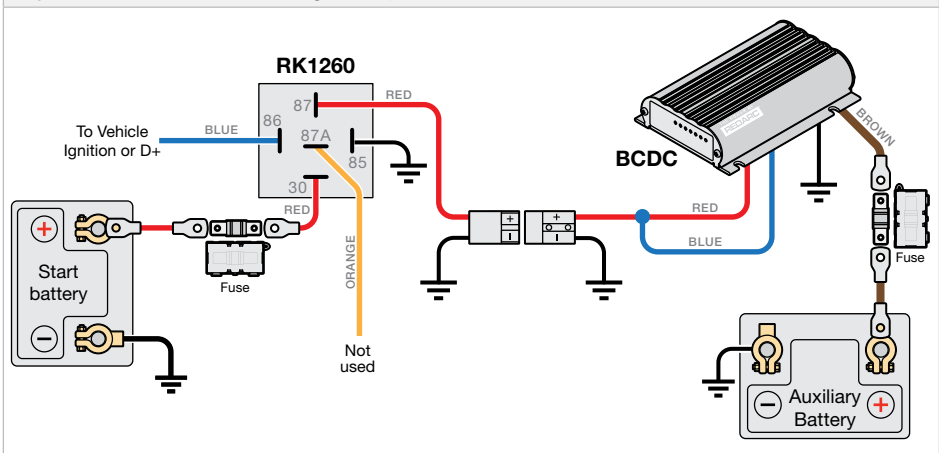

3.7.6 SOLAR PANEL(S) – YELLOW CABLE

The **YELLOW** wire connects solar input to the BCDC. If solar is not installed, tape over the end of the wire.

IMPORTANT: DO NOT connect solar panels that have inbuilt regulators. The BCDC Core has an inbuilt regulator that may not function correctly if regulated solar panels are connected.

NOTE: Most residential solar panels are not suitable for use with BCDC as they have an open circuit voltage that exceeds the 32V limit of the BCDC Core input.

CONNECTING MULTIPLE SOLAR PANELS

There is no limitation on how many solar panels you can connect in parallel to your BCDC, but you will need to size the cables correctly.

When connecting multiple 12V solar panels, it is important to connect them in parallel. Connecting in parallel ensures the output voltage remains the same while increasing the overall power output of the array.

Figure 3.7.6.1: Connecting solar panels in parallel

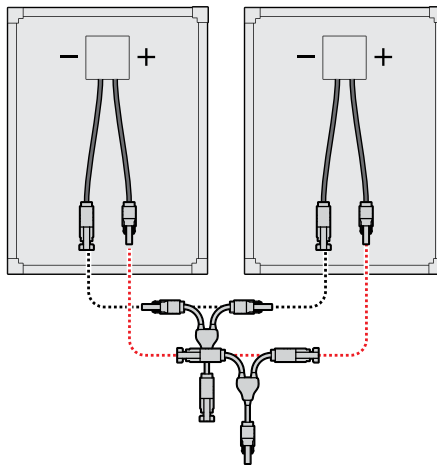

Example only, panels/configurations may vary.

The BCDC Core can be connected to a solar panel array with a larger wattage than the BCDC's maximum Output Power rating (refer to "[Table 3.7.1: Maximum Output Power rating](#)" (page 25)).

The Battery Charger will automatically limit power going to the unit if the panels supply more than the maximum wattage needed.

Table 3.7.1: Maximum Output Power rating

Model	BCDCN1225	BCDCN1240
Maximum Output Power rating	375 W	600 W

While output power may be limited in peak solar conditions, having this additional solar panel wattage is beneficial for solar power availability when conditions are sub-optimal.

This will allow the BCDC Core to charge more effectively earlier in the day and later into the night when solar irradiance is lower, when panels are shaded or when they cannot be angled directly towards the sun.

3.7.7 OPTIONAL LED – GREEN WIRE

The **GREEN** wire is provided to either connect an external LED (optional) when using A, B and C battery profiles or to connect to the **ORANGE** wire for Lithium profile selection.

If the **GREEN** wire is connected to an LED, it will function as an indicator light to let you know the BCDC is charging. If used, this external LED is either OFF when the BCDC is not charging or ON when the BCDC is charging. If the LED begins to FLASH see "[4.1 Error Codes](#)" (page 28).

Only connect the **GREEN** wire to the **ORANGE** wire when using a Lithium profile battery, connecting these wires together sets the BCDC Core to Lithium mode.

NOTE: The **GREEN** wire output is not suitable for running a incandescent globes and 12V LEDs (3V with integrated resistor) will not operate correctly if installed.

Figure 3.7.7.1: Connecting the **GREEN** wire

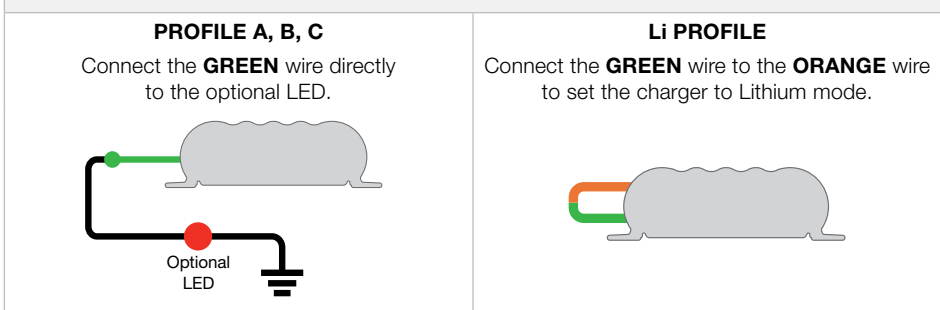

3.8 Maintenance

Regularly check your BCDC setup and make sure wiring and cable connections are secure to avoid damaging the BCDC Core, the auxiliary battery and the vehicles start battery.

4 TROUBLESHOOTING

There are no LEDs ON at all.

This indicates that there is no battery connected to the output (BROWN wire) AND the input (YELLOW/RED wire) of the charger is not connected.

1. Check all wiring to the charger and battery, particularly the Ground (BLACK wire).
2. Check fuses are intact and properly connected.

If the problem persists, contact your local Auto-Electrician.

The Charge Profile LED is flashing.

The unit is in standby, this indicates:

- There is no valid charging source, therefore, the input is below the turn on threshold (see "4.2 Turn On/Off Thresholds" (page 29)).
 - There is no connection to the auxiliary battery.
1. Check that the Vehicle (RED wire) and/or Solar (YELLOW wire) are electrically connected.
 - The Vehicle (RED wire) should connect directly to the Vehicle battery positive terminal via an adequately rated fuse.
 - The Solar (YELLOW wire) should connect directly to the Solar Panel positive terminal/wire.
 2. Check that the Ground (BLACK wire) is connected to the Auxiliary battery and Chassis Earth and/or the Solar Panel negative terminal/wire.
 3. Check all wiring to the Auxiliary battery, particularly the Ground (BLACK wire).
 4. Check fuses are intact and properly connected.

If the problem persists, see the relevant points following.

I have Solar connected but the Solar LED is OFF.

This indicates that the required turn ON conditions for this source have not been met. Either the Open Circuit Voltage at the YELLOW wire on the charger is below 9V or there is not sufficient power available from the Solar Panel (due to poor light conditions or a faulty panel).

1. Is the sun out? No or low sunlight levels mean low power to your solar panels.
2. Check that the solar panel is not being shaded (by a tree etc.).
3. Check the voltage at the YELLOW wire, as close as possible to the charger, is above 9V.
4. Check all wiring to the Solar Panel, particularly the Ground (BLACK wire).
5. Ensure you have an unregulated solar panel.

Allow up to 2 minutes after any change for the unit to recognise the input, if the problem persists, contact your local Auto-Electrician.

The BCDC is connected to the Vehicle but the Vehicle LED is OFF.

This indicates that the required turn ON conditions for this source have not been met OR the Solar input is supplying the full input power requirements of the charger.

With the BLUE wire left unconnected, the voltage at the RED wire must be above 12.9V for a 12V installation or above 25.8V for a 24V installation.

With the BLUE wire connected to Ignition, Ignition must be on and the voltage at the RED wire must be above 12.0V for a 12V installation or above 24.0V for a 24V installation.

1. Check that the vehicle is running.
2. Check the voltage on the RED wire is above the required turn ON threshold for your installation (see "4.2 Turn On/Off Thresholds" (page 29)).
3. Check all wiring to the Vehicle battery, particularly the Ground wire (BLACK).
4. Check connection to the auxiliary battery and auxiliary battery ground connection

If the problem persists, contact your local Auto-Electrician.

4.1 Error Codes

In the event of a fault with the unit installation, either battery or solar panel, ALL the LEDs on the unit will flash to indicate the fault type.

Table 4.1.1: Flashing Sequences	
LED State	Description
1 flash (followed by 3.5 second off)	Internal Hardware Fault
2 flash (followed by 3.5 second off)	Unit under temp fault
3 flash (followed by 3.5 second off)	Unit over temp fault
4 flash (followed by 3.5 second off)	Output Battery Fault (Volts too high)
5 flash (followed by 3.5 second off)	Input under voltage (Battery) ^{*3}
6 flash (followed by 3.5 second off)	Input over voltage (Battery or Solar panel) or the Solar Panel is connected in reverse polairty.

^{*3} If the unit is being supplied power from the vehicle and solar simultaneously and ONE of those sources is undervoltage, that specific source LED will flash 5 times. If the unit is being supplied power from the vehicle and solar with BOTH sources under voltage, OR if the unit is being supplied power from one input only and that input is undervoltage, ALL LED's will flash 5 times.

4.2 Turn On/Off Thresholds

Table 4.2.1: Turn On/Off Thresholds						
	Input	12V Vehicle Input		24V Vehicle Input		Solar
	Input Trigger Settings	Standard	Low Voltage	Standard	Low Voltage	N/A
Input Open Circuit Low voltage conditions *1	Turn ON ABOVE	12.9V	12.0V	25.8V	24.0V	9.0V
	Turn OFF BELOW	12.7V	11.9V	25.4V	23.8V	9.0V
Input Loaded Low voltage conditions *2	Stop Charging BELOW	12.2V	11.3V	24.4V	22.6V	N/A
	Turn OFF instantly BELOW	8.0V		8.0V		9.0V
	Turn OFF after 20 s BELOW	9.0V		9.0V		N/A
Input Overvoltage shutdown	Turn ON BELOW	15.5V		32.0V		32.0V
	Turn OFF instantly ABOVE	16.0V		32.5V		33.0V
	Turn OFF after 20 s ABOVE	15.6V		32.1V		N/A
Output Undervoltage shutdown *1	Shutdown if Output Battery < 0V					

*1 Tested every 100 seconds | *2 Tested constantly

There is a maximum 20 second delay before the charger will produce an output any time a source is introduced into the system, this allows the unit to provide optimum input sharing and effective battery isolation.

5 FREQUENTLY ASKED QUESTIONS

The BCDC Core Input turns ON at 12.9V (12V) and OFF at 12.7V (11.9V), but you say it operates down to 9V, explain?

The BCDC Core Input will turn OFF for a split second every 100 seconds to measure the unloaded voltage at the battery. When the BCDC Core Input turns off, it is not drawing any load from the start battery. No load means that there is no voltage drop over the cable run. This allows the BCDC Core Input to measure the actual battery voltage, or the voltage at the battery. If this actual battery voltage is below 12.7V (11.9V), the BCDC Core Input will turn OFF. At any other time during the charging process if the voltage at the BCDC Core Input drops below 9V, the BCDC Core Input will turn OFF.

How does the BCDC Core Input charge an Auxiliary battery at 14V when it only gets 9V in?

The BCDC Core Input can act as both a reducer and a booster, so it can operate from a voltage of above, equal to or below the desired output voltage. The unit is also microprocessor controlled allowing it to output a REDARC proprietary charging algorithm independent of the input. This allows the unit to charge specific to the battery type even if the input voltage is low due to voltage drop.

Where should I mount the BCDC Core Input Unit?

The BCDC Core Input should be mounted as close as possible to the battery being charged (generally called the Auxiliary or House battery). If the BCDC Core Input is to be mounted into a Caravan or Camper, near or in the battery compartment is generally the best position. It is also a good idea to mount the BCDC Core Input to a metal surface if possible to ensure optimal heat dissipation, though this is not crucial.

What does the charger do if the temperature around it rises above its operating temperature?

As the temperature of the BCDC Core Input rises above a certain level the current capacity of the output is decreased gradually in order protect both the battery and the BCDC Core Input unit.

If I use the BCDC Core Input to charge my auxiliary battery do I still need to install a battery isolator?

The BCDC Core Input incorporates the functionality of a battery isolator, it will turn ON and start charging when it senses that the vehicle has started and similarly it will turn OFF when the vehicle is turned OFF.

I've heard that you shouldn't charge two batteries of different chemistries from the same source, will I have any problems charging my AGM or Gel auxiliary battery from my Lead Acid start battery?

The BCDC Core Input does not 'link' the batteries together like a battery isolator does, it is a DC-DC Battery Charger. The output from the unit is tailored specifically to the selected output battery type, and therefore allows the optimal charging of the auxiliary battery, no matter what chemistry your start battery is.

My BCDC Core Input is setup for 12V Alternator input but will not start when the vehicle is turned On, I've followed the trouble shooting guide and the setup is fine, what's the problem?

The most likely cause of this issue is that the BCDC Core Input is somehow stuck in 24V mode. Try disconnecting the Vehicle wire (RED) and the Output wire (BROWN) and then reconnecting it. If the problem persists, contact REDARC.

Can the BCDC Core Input charge from Solar and Vehicle power at the same time?

Yes. The BCDC Core Input will always attempt to supply power from the Solar source first (when available) and will supplement this input with power from the Vehicle source (when available).

Can the BCDC Core Input operate with only a single power source input?

Yes. The BCDC Core Input will operate as a stand-alone solar regulator when only Solar (YELLOW wire) is connected or it will operate as a DC charger when only the Vehicle (RED wire) is connected.

6 SPECIFICATIONS

Part Number	BCDCN1225		BCDCN1240	
Continuous Current Rating	25 A		40 A	
Maximum Current Rating	35 A		55 A	
Vehicle Input Fuse Rating and Output Fuse Rating	40 A (Not Supplied) REDARC FK40 recommended		60 A (Not Supplied) REDARC FK60 recommended	
Maximum Output Power	375 W		600 W	
Vehicle Input Voltage Range^{*1}	9 to 32 V			
Solar Input Voltage Range^{*1}	9 to 32 V (unregulated only)			
Output Battery Type	Standard Lead Acid, Calcium content, Gel, AGM or LiFePO ₄ type only			
Charging Profile	A	B	C	Li
Maximum Voltage^{*1}	14.6 V	15.0 V	15.3 V	14.5 V
Float Voltage^{*1}	13.3 V			13.6 V
No Load Current	< 100 mA			
Standby Current	< 8 mA			
Charging Temperature	Charging Profile: A/B/C Output Battery > 10.5V		5°F to +176°F/ -15°C to +80°C	
	Charging Profile: A/B/C Output Battery < 10.5V		32°F to +176°F/ 0°C to +80°C	
	Charging Profile: Li LiFePO ₄ Output Battery		32°F to +176°F/ 0°C to +80°C	
Minimum O/P Battery Volts	0.1 V			
Weight	900 g / 31.7 oz			
Dimensions (L x W x H)	165 x 120 x 37 mm / 6.5" x 4.75" x 1.47"			
Warranty	2 years			
Standards	CISPR11, ECE Reg.10			

*1 Voltages Specified are ± 100 mV, refer to "Table 4.2.1: Turn On/Off Thresholds" on page 29.

WARRANTY

LIMITED WARRANTY

For full warranty terms and conditions, visit the Warranty page of the REDARC website. Refer to the web address and contact details applicable to your region.

Australia, New Zealand & Europe

www.redarc.com.au/warranty

REDARC Electronics Pty Ltd
23 Brodie Road (North),
Lonsdale SA 5160
Australia

North America

www.redarcelectronics.com/warranty

REDARC Corporation
c/o Shallco, Inc.
308 Component Dr.
Smithfield, NC 27577
USA

Australia +61 8 8322 4848
New Zealand +64-9-222-1024
UK & Europe +44 (0)20 3930 8109

USA +1 (704) 247-5150
Canada +1 (604) 260-5512
Mexico +52 (558) 526-2898

CHECKING THE PRODUCT SERIAL NUMBER

The Product Serial Number is located on the Main Unit and on the product packaging.

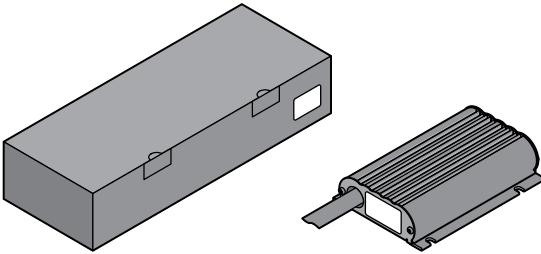

CE REDARC Electronics Pty Ltd
23 Brodie Road (North), Lonsdale South Australia 5160, Australia

Design and specifications are subject to change without notice | Copyright © 2022 REDARC Electronics Pty Ltd. All rights reserved REDARC®, THE POWER OF REDARC®, and BCDC® are trademarks of REDARC Electronics Pty Ltd.

CONTACT

Tech Support 1300 REDARC
Head Office +61 8 8322 4848
New Zealand +64 9 222 1024
UK & Europe +44 (0)20 3930 8109

redarc.com.au

USA +1 (704) 247 5150
Canada +1 (604) 260 5512
Mexico +52 (558) 526-2898

redarcelectronics.com

THE POWER OF

