



# FITTING INSTRUCTIONS

Part Number: **3670010**  
Product **SUMMIT REAR STEP TOW BAR (RSTB)**  
Description:  
Suited to **Volkswagon Amarok 2011 ON**  
vehicle/s:  
Optional Fit Kit: **3570040 – SUMMIT RSTB KIT 11ON SUITS 3670010**

## WARNING

### NOTE THE FOLLOWING:

- ◆ This product must be installed exactly as per these instructions using only the hardware supplied.
- ◆ In the event of damage to any tow bar component, contact your nearest authorised ARB stockist.
- ◆ Do not use this product for any vehicle make or model, other than those specified by ARB.
- ◆ Do not remove labels from this tow bar.
- ◆ This product or its fixing must not be modified in any way.
- ◆ The installation of this product may require the use of specialized tools and/or techniques
- ◆ It is recommended that this product is only installed by trained personnel.
- ◆ These instructions are correct as at the publication date. ARB Corporation Ltd. cannot be held responsible for the impact of any changes subsequently made by the vehicle manufacturer.
- ◆ During installation, it is the duty of the installer to check correct operation/clearances of all components.
- ◆ Work safely at all times.
- ◆ Unless otherwise instructed, tighten fasteners to specified torque.
- ◆ The eyelets on the rear bar have been designed and tested for connection of trailer safety chains. They are not to be used for recovery or direct towing.
- ◆ For recovery, fit a suitable and rated tow hitch to the central tow hitch receiver.
- ◆ Position high lift jack at lift locations beneath the middle of the wings and corner of the RSTB. Do not lift directly from the end of the wing.
- ◆ When using the tow hitch receiver, the centre panel should be in the raised position.

## **ARB 4x4 ACCESSORIES**

### Corporate Head Office

42-44 Garden St  
Kilsyth, Victoria  
AUSTRALIA 3137

Tel: +61 (3) 9761 6622  
Fax: +61 (3) 9761 6807

Australian enquiries  
North & South American enquiries  
Other international enquiries

sales@arb.com.au  
sales@arb.com.au  
exports@arb.com.au

**www.arb.com.au**

# GENERAL CARE AND MAINTENANCE

By choosing an ARB Bar, you have bought a product that is one of the most sought after 4WD products in the world. Your bar is a properly engineered, reliable, quality accessory that represents excellent value. To keep your bar in original condition it is important to care and maintain it following these recommendations:



- Prior to exposure to the weather your bar should be treated to a Canuba based polish on all exposed surfaces. It is recommended that this is performed on a six monthly basis or following exposure to salt, mud, sand or other contaminants.
- As part of any Pre Trip Preparation, or on an annual basis, it is recommended that a thorough visual inspection of the bar is carried out, making sure that all bolts and other components are torqued to the correct specification. Also check that all wiring sheaths, connectors, and fittings are free of damage. Replace any components as necessary. This service can be performed by your local authorized ARB Stockist.

## FITTING REQUIREMENTS

### REQUIRED TOOLS FOR FITMENT OF PRODUCT:

BASIC TOOL KIT	SIDE CUTTERS
INSULATION TAPE	70MM HOLE SAW BIT
DEUTSCH CRIMPING TOOL	WIRE STRIPPER
NEEDLE NOSE PLIERS	POWER DRILL
ALLEN KEY SET	SOCKET SET
FINE ROUND FILE	TAPE MEASURE
MASKING TAPE	RUST PREVENTATIVE PAINT
TORQUE WRENCH 9-77Nm	

### HAVE AVAILABLE THESE SAFETY ITEMS WHEN FITTING PRODUCT:

Protective eyewear		Hearing protection	
--------------------	---	--------------------	---

**NOTE: 'WARNING' notes in the fitting procedure relate to OHS situations, where to avoid a potentially hazardous situation it is suggested that protective safety gear be worn or a safe work procedure be employed. If these notes and warnings are not heeded, injury may result.**

### FASTENER TORQUE SETTINGS:

SIZE	Torque Nm	Torque lbft
M6	9Nm	7lbft
M8	22Nm	16lbft
M10	44Nm	32lbft
M12x1.75	77Nm	57lbft
M14	185Nm	135lbft

<b>RSTB PARTS LISTING</b>			
<b>APPLICATION</b>	<b>PART NO.</b>	<b>QTY</b>	<b>DESCRIPTION</b>
<b>PREPARE REAR STEP TOW BAR (RSTB)</b>	4654293	1	FRAME ASM-WELDED AMAROK 11ON
	6151715	14	NUT M6 CAGED 3.6-4.5MM 836-D
	6523187	1	LIFT UP PANEL
	5670026	2	SPRING EXT 11.25 OD x 43
	6151443	2	SCREW BTN HD M6 x 20 BZ
	6151046	4	WASHER FLAT M6 TZP480
	6151549	2	NUT NYLOC M6 x 1.0 GR8.8 BTZP480
<b>RSTB TO VEHICLE</b>	6523182	1	PANEL BEAVER-AMAROK
	3750173R	1	BRACKET-PANEL BEAVER RH
	3750173L	1	BRACKET-PANEL BEAVER LH
	6151526	4	NUT M6 CAGED 1.7-2.5MM
	6821189	4	PLASTIC SNAP-IN LARGE GROMMET
	6151213	4	BOLT M6 x 1.0 x 20 Gd8.8 BZ
	4581082	6	WASHER FLAT M6 x 12 x 1.3 BLK ZN
	6151173	2	FLANGE NUT-M6 BZ
	5848302	4	PACKER RB NYLON
	6151443	6	SCREW BTN HD M6 x 20 BZ
	4584329	6	WASHER FLAT M6x12.2x1.2 BTZP480
	4654084	2	NUT PLATE M10X1.5
	6151232	2	BOLT HX HD M10X1.5X30
	4584296	2	WASHER FLAT M10X30X5
	6151539	2	BOLT HX FL M14X1.5X110
	6151540	2	FLANGE NUT M14X1.5
	6151098	2	BOLT HX FL M12X1.5X40
<b>FITTING KIT 3570040 MY11-16 VEHICLES ONLY</b>	6151098	2	<i>BOLT HX FL M12X1.5X40</i>
	4584363	4	<i>WASHER FLAT M12X26X4</i>
	4584222	2	<i>NUT PLATE M12X1.75</i>
	6151255	2	<i>BOLT HX M12X1.75X40</i>
<b>PANELS TO RSTB</b>	6523183R	1	PANEL RSTB STEP-AMAROK RH
	6523183L	1	PANEL RSTB STEP-AMAROK LH
	3195000	1	PLATE-EXTRUSION AMAROK
	6151443	8	SCREW BTN HD M6 x 20 BZ
	4584329	8	WASHER FLAT M6x12.2x1.2 BTZP480
	4581082	4	WASHER FLAT M6 x 12 x 1.3 BLK ZN
	6151173	4	FLANGE NUT-M6 BZ
	6151256	4	SCREW BTN HD M6 x 16 SS
	6821270	1	NARVA 90810 LED LMAP
	3163125	1	MOLDING RSTB LIGHT BEZEL
	3759536	1	BRKT LED MOUNT
6821116	2	GROMMET NYLON SNAP IN TYPE	
<b>PREPARE RSTB/VEHICLE FOR PANELS</b>	3750172R	1	BRKT ASM. -WING MOUNT RH
	3750172L	1	BRKT ASM. -WING MOUNT LH
	6151730	10	BOLT HX FL M8X1.25X20
	6151655	4	NUT HX FL M8X1.25
	3750119R	1	BRKT-WING MOUNT RH
	3750119L	1	BRKT-WING MOUNT LH
	3194723	2	PLATE NUT ASM
	3194724	2	PLATE NUT ASM
	3759843	4	BRKT PARK SENSOR
	6781437	3	TAPE 3M4991 2.3mm 20X25 8 PCS
	6781427	4	ADHESIVE STRIP BUTYL 20 X 25
	3789677	1	TEMPLATE-AMAROK RR QTR CUT

## RSTB PARTS LISTING

APPLICATION	PART NO.	QTY	DESCRIPTION
<b>PANELS TO RSTB/VEHICLE</b>	6151730	8	BOLT HX FL M8X1.25X20
	6151655	4	NUT HX FL M8X1.25
	6151032	10	NUT NYLOC M8 x 1.25
	6151256	8	SCREW BTN HD M6 x 16 SS
	4581082	6	WASHER FLAT M6 x 12 x 1.3 BLK ZN
	6151173	2	FLANGE NUT-M6 BZ
	6151549	2	NUT NYLOC M6 x 1.0 GR8.8 BTZP480
	4581304	8	WASHER FLAT M6 S/S
	6523184	1	PANEL DIFFUSER RH-AMAROK
	6523185	1	PANEL DIFFUSER LH-AMAROK
	3131538R	1	WING ASM-AMAROK RH
3131538L	1	WING ASM-AMAROK LH	
<b>TOW TONGUE</b>	4761170	1	TOW TONGUE 45 DEG
	55010	1	TOW BAR PULL PIN
	55020	1	SPRING CLIP
	180302	10	CABLE TIE 200MM
<b><i>FITTING KIT 3570040 MY11-16 VEHICLES ONLY</i></b>	3163169	4	BLANKING PLUG BLACK
	3750118	1	BRACKET CAMERA RELOCATION
	4584329	2	WASHER FLAT M6x12.2x1.2 BTZP480
	6151173	2	FLANGE NUT-M6 BZ
	6151443	2	SCREW BTN HD M6 x 20 BZ

## TRAILER WIRING

The following trailer wiring solutions can be purchased from ARB. Purchase the main wiring harness with ECU (Part no. 3600010) in conjunction with the appropriate socket and tail listed below. Alternatively, this product is compatible with the factory trailer wiring solution.

To install this loom, a crimping tool suitable for crimping contact typesize16Deutsch pins is required. Suitable crimping tools as shown can be purchased from auto electrical wholesalers.



APPLICATION	PART NO.	QTY	DESCRIPTION
<b>TRAILER WIRING</b>	3600010	1	RSTB WIRING INCLUDING ECU
	3600020	1	RSTB SOCKET & TAIL   7 PIN FLAT
	3600030	1	RSTB SOCKET & TAIL   12 PIN FLAT
	3600040	1	RSTB SOCKET & TAIL   7 PIN ROUND LRG
	3600050	1	RSTB SOCKET & TAIL   7 PIN ROUND SML

## OPTIONAL ACCESSORIES

The following ARB accessories can be fitted to this product:

APPLICATION	PART NO.	QTY	DESCRIPTION
<b>OPTIONAL ACCESSORIES</b>	171403	1	ARB AIR LINE FITTING
	10600030	1	ARB TRAILER CAMERA KIT
	58X22/A	1	RECOVERY HITCH AND SHACKLE
	6594050	1	50 AMP ANDERSON PLUG

			
AIR LINE FITTING	TRAILER CAMERA KIT	RECOVERY HITCH	ANDERSON PLUG

## GENUINE ACCESSORIES REMOVAL

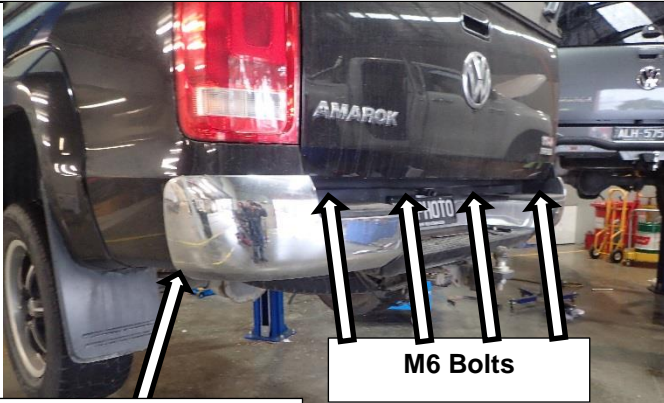

Parking sensor  
harness connector

M6 Bolts

### Removal of rear bumper bar:

1. Remove the rear bumper bar assembly from Vehicle. First remove 4 x M6 bolts from the top of the rear bumper. Disconnect the parking sensor harness, located near end of LH chassis rail.

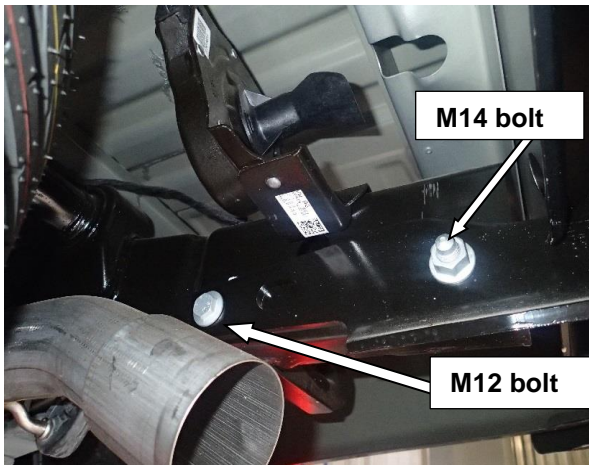

M14 bolt

M12 bolt

2. Then remove 2 x M12 bolts and 2 x M14 nuts and bolts that fix the bar assembly, from each side as shown. (RH shown)

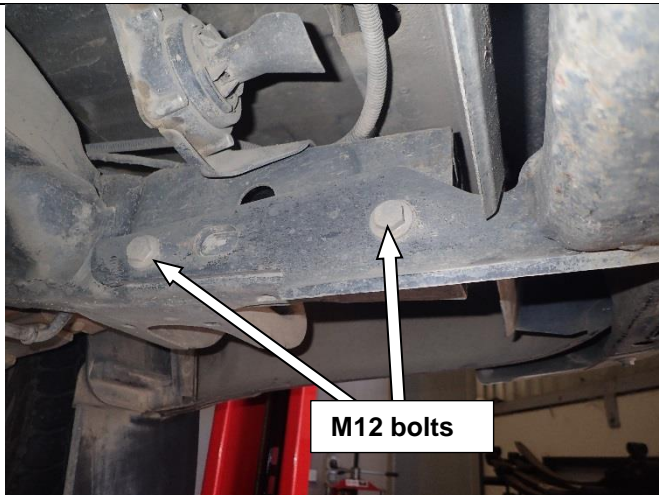

M12 bolts

3. For MY11-15 4 X M12 Bolts as shown. (RH shown)

**Note: If fitted the reverse parking camera must be removed.**



4. Remove the spare wheel from beneath the tub using the wheel nut wrench and jack handle pieces supplied with the vehicle.

*(refer to owner's manual for correct procedure)*



The plastic tread covers of the rear bar must be removed to access all bolts



5. Once the bumper assembly has been removed from the vehicle, the bumper assembly must be disassembled to remove the rear parking sensors and harness.
6. Take note of the orientation of the sensor in the OE bar.

**Note: Take care not to damage parking sensor during removal.**



7. Do not lose the clear silicone grommets/washers. The grommets/washers must be retained on the sensor

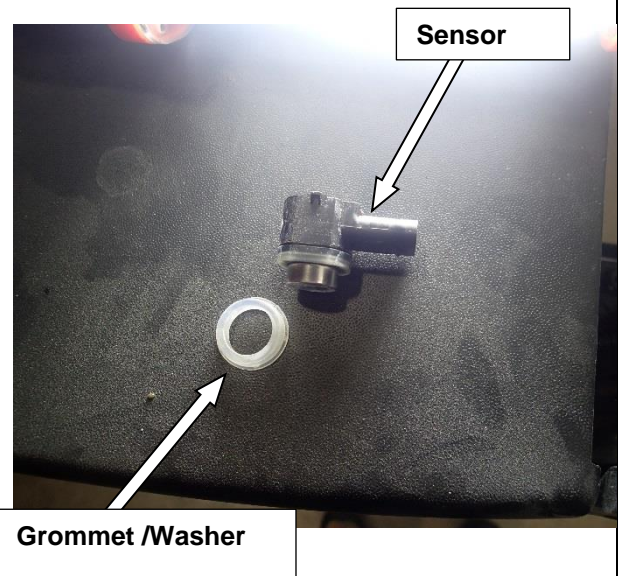

## VEHICLE/RSTB WIRING

A trailer wiring solution that incorporates a smart ECU is available for this vehicle. To fit this solution, the rear vehicle wiring harness must be cut and high quality, waterproof Deutsch connectors installed to provide signal pickup points for the ECU.

To install this loom, a suitable crimp tool is required. Refer to Page 5 for more details about the crimp tool.

Follow the steps below to install the trailer wiring solution:

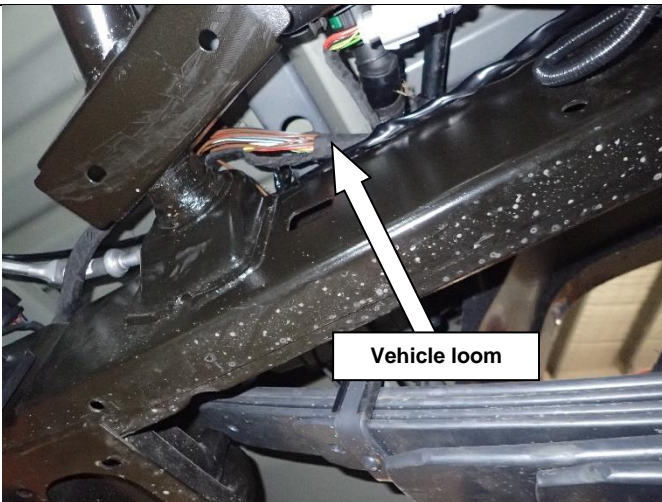

8. Locate the vehicle loom on the left hand chassis rail near LH spare wheel brace as shown. Remove tape if present and expose 200mm of the following coloured wires from the split corrugated tubing:

Black/White	(LH Indicator)
Black/Blue	(Reverse)
Black/Green	(RH Indicator)
Black/Red	(Brakes)
Grey/Black	(Clearance)



**Note: Prior to cutting the exposed wires, please ensure and re-check (with a test light or multimeter) that the correct wires have been identified as per their corresponding function, as there are multiple wires of the same colour in the vehicle loom.**

9. Cut a 90mm section from the centre of the 5 exposed wires. This will leave ~55mm of wire before they re-enter the corrugated tubing at each end.

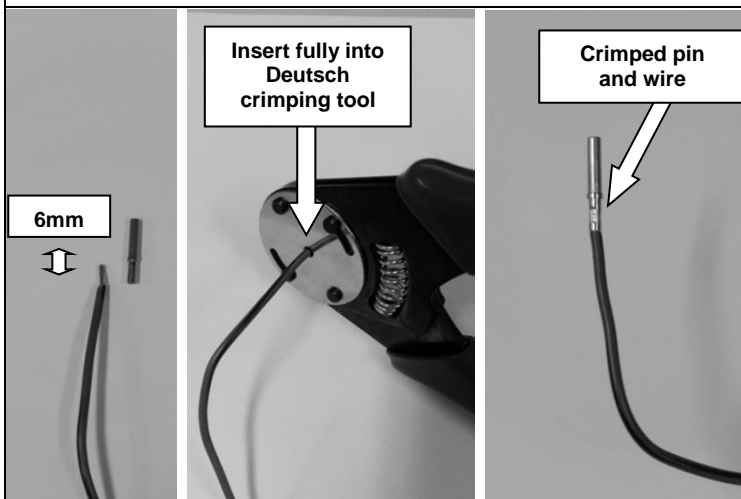

10. Remove 6mm of the plastic insulation coating from the end of each newly cut wire.

11. Insert each wire into the shorter end of a metal Deutsch pin.

12. Insert the longer end of the metal Deutsch pin into a crimping tool and crimp the wire and pin together as shown.



Plastic cover on the front side of connector

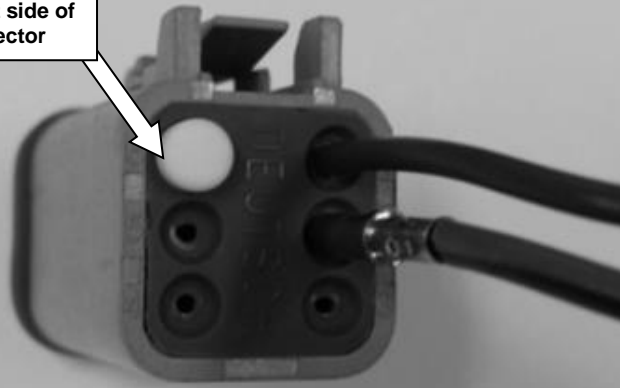

13. Insert one set of wires into a male 6-pin connector from the back in the following order:

Pin position	Wire colour
1	Black/White
2	Black/Blue
3	Black/Green
4	Black/Red
5	Grey/Black

**Note:** Pin positions are shown on the back of the connector.

14. Insert the white blank pin into position 6 as shown in the previous step.
15. Insert the plastic cover to the front of the connector as shown.
16. Repeat steps 11-13 for the other connector.



Position ECU on top of LH chassis rail

17. Position ECU on top of LH chassis rail as shown. Ensure ECU is in a position close to factory wiring to be away from body movement. Secure to chassis rail using the ECU mounting holes with 2 cable ties.
18. Connect the ECU unit to the RSTB wiring harness using the large 12 pin connector.

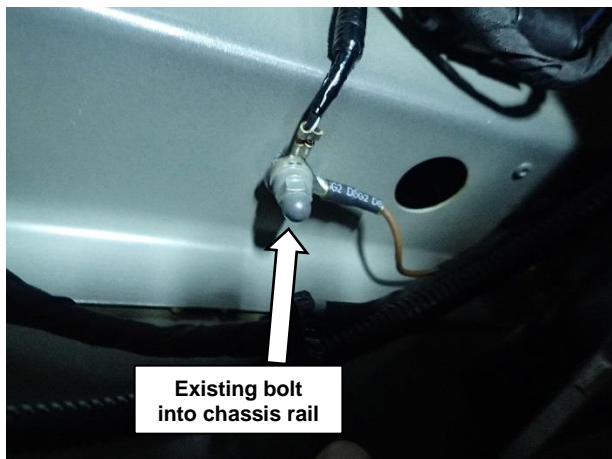

Existing bolt into chassis rail

19. Connect the ground wire of the RSTB harness to the factory earth bolt on the tub close to the rear bumper.

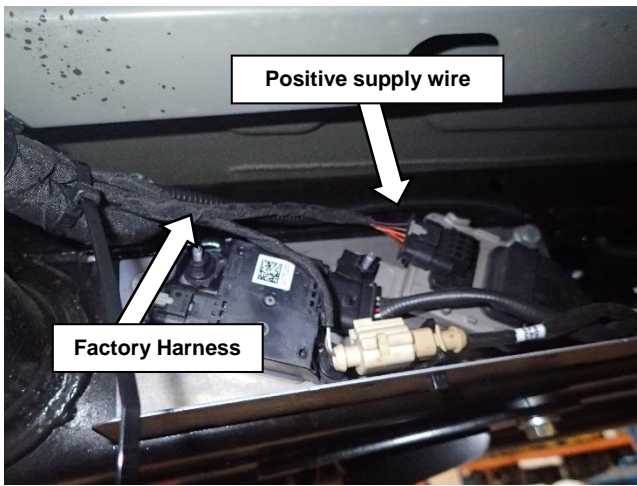

Positive supply wire

Factory Harness

20. Route the positive supply wire to the front of the vehicle following the existing factory vehicle harness along the left chassis rail.
 

**Warning: Make sure all wires are securely fastened away from any hot, sharp or moving surfaces. Do not fasten wiring harness to fuel or brake lines.**



21. Continue routing the positive supply wire through the engine bay to the battery.
22. Connect the positive supply wire to the positive terminal of the battery using the existing bolt as shown.

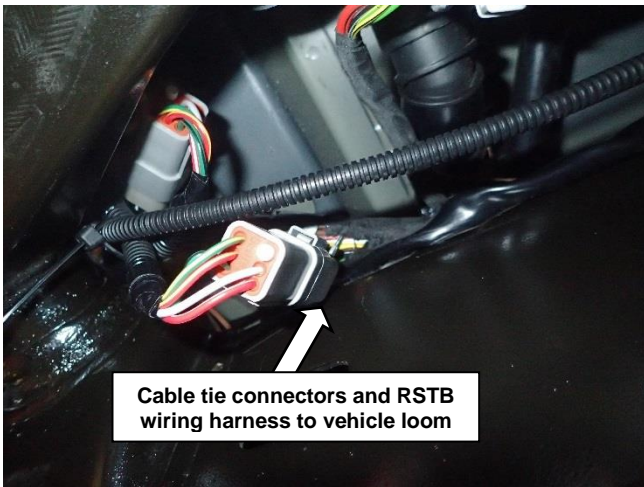

Cable tie connectors and RSTB wiring harness to vehicle loom

23. Connect the RSTB wiring harness to the 2 male 6-pin connectors.
 

**Note: The RSTB wiring harness is not polarity sensitive in this region so the male 6-pin connectors can be connected to either female connector.**
24. Ensure vehicle tail lights function correctly.
25. Fasten the connectors to the vehicle loom using the cable ties provided.
26. Re-wrap the un-cut wires with the existing split corrugated tubing and new tape.
27. Tidy and fasten all wiring using the cable ties provided.
 

**Warning: Make sure all wires are securely fastened away from any hot, sharp or moving surfaces. Do not fasten wiring harness to fuel or brake lines.**

## PREPARE REAR STEP TOW BAR (RSTB)



28. Place the RSTB on a flat surface that will not damage its coating as shown.

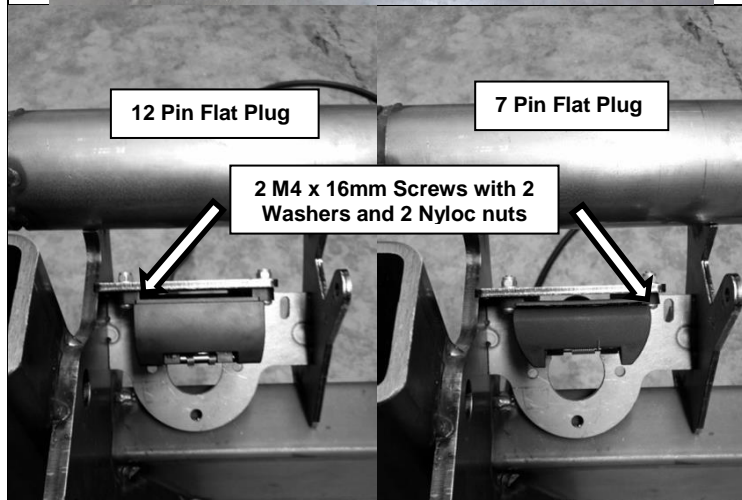

### For fitment of flat trailer plugs:

29. Using the 2 rear mounting holes cut in the bracket and fasteners supplied with the trailer plug, attach the trailer plug to the trailer plug bracket on the RSTB.

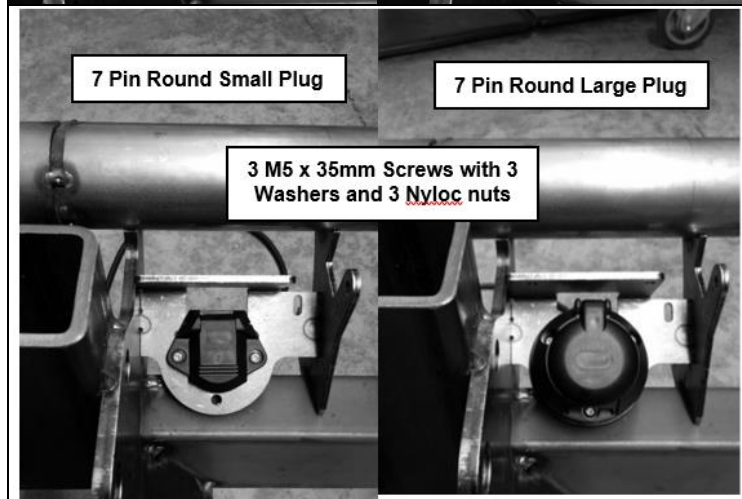

### For fitment of round trailer plugs:

30. Using the appropriate mounting holes as shown and fasteners supplied with the trailer plug, attach the trailer plug to the trailer plug bracket on the RSTB.



## PREPARE REAR STEP TOW BAR (RSTB)

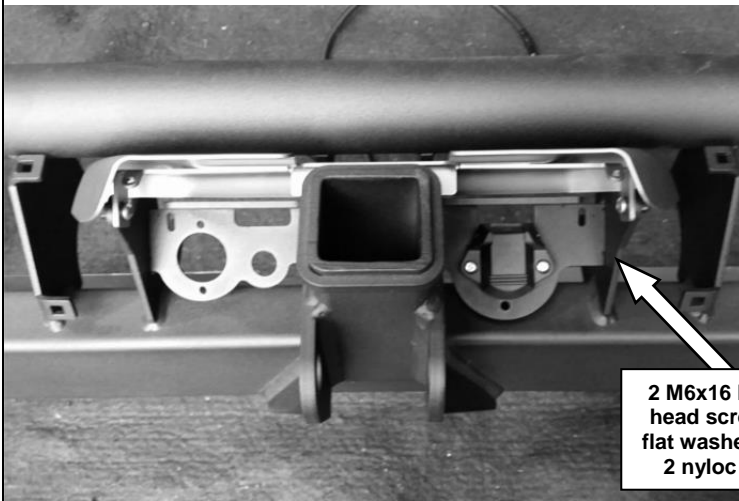

31. Attach the lift up panel to the pivot plates on the RSTB using 2 M6x16 button head screws, 4 M6 flat washers and 2 M6 nyloc nuts. 2 x large flat washers are placed between the flip up panel and frame.
32. Tighten the screws enough to ensure the lift up panel is centralised with minimal sideways movement, but still able to lift up and down freely.

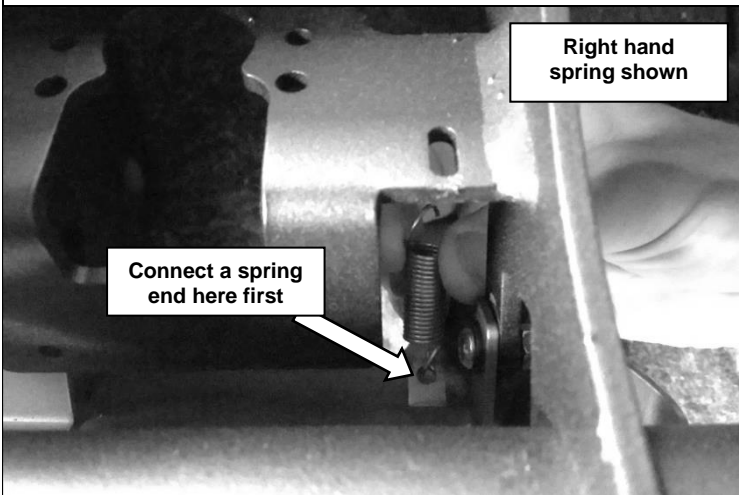
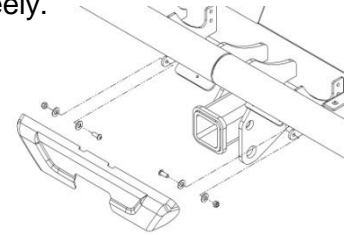

33. Connect 2 springs between the RSTB and lift up panel. From above, first connect one end of each spring to the lift up panel as shown.

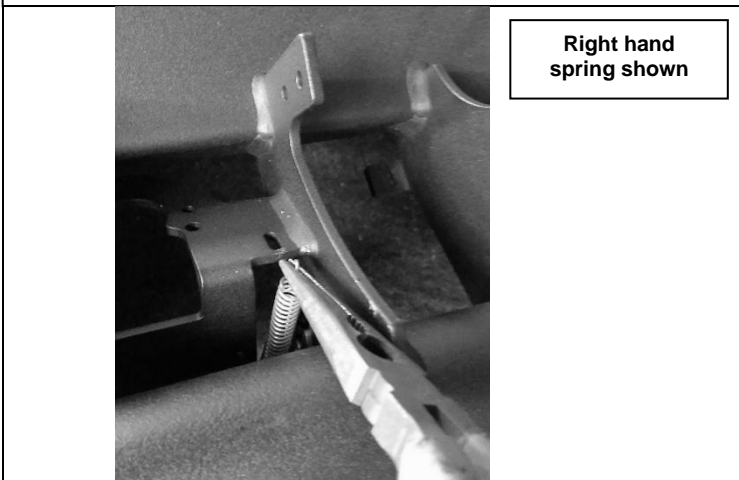
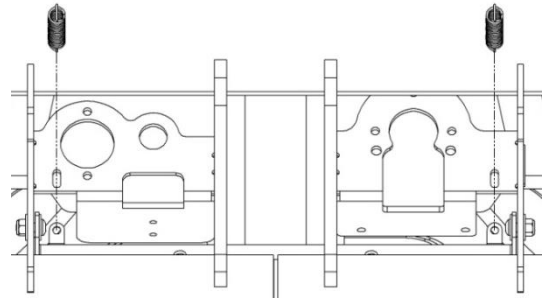

34. Using pliers, stretch the free end of each spring up to the bracket on the RSTB as shown.



**Warning:** Safety glasses should be worn for this operation as the spring may slip off the pliers if not clamped tightly.



## PREPARE REAR STEP TOW BAR (RSTB)

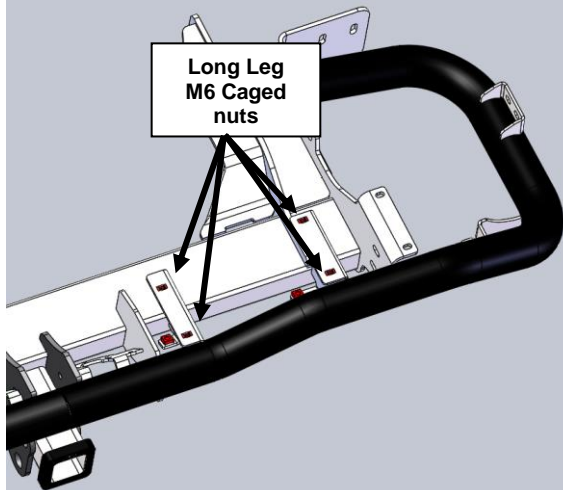

35. Fit 8 long-leg M6 caged nuts to the RSTB. Fit 4 x caged nuts to the right side as shown and 4 x cage nuts to the left hand side.

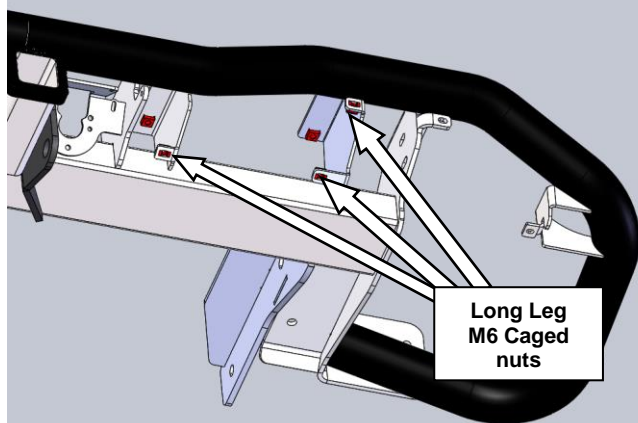

36. Rotate and support the RSTB and fit 6 long-leg M6 caged nuts. Fit 3 caged nuts to the right side as shown and 3 cage nuts to the left hand side

## For MY11-15 Vehicles only RSTB TO VEHICLE

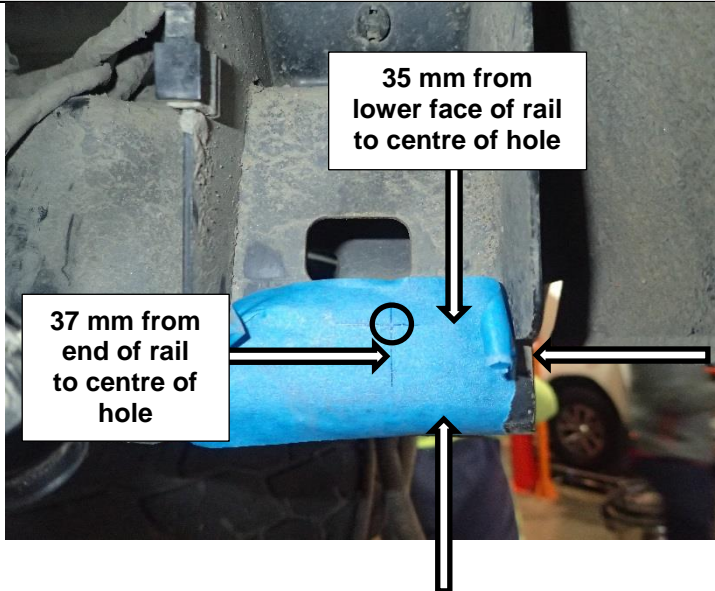

37. With the rear bar removed and prior to fitting the ARB rear. Mark and drill 1 x Ø13mm hole on the outside face of both chassis rails.
38. Add anti-corrosion touch up paint to area drilled.

**Note:** hole must be in line with M12 weldnut on inside face of rail.



**WARNING:** Drilling & cutting operations can result in flying debris. Eye and ear safety protection should be worn.



39. When fitting bar to the vehicle on MY 11-16 vehicles, fit M12 Bolt and washer and M12 Nut plate in to chassis rail

M12 bolt and washer

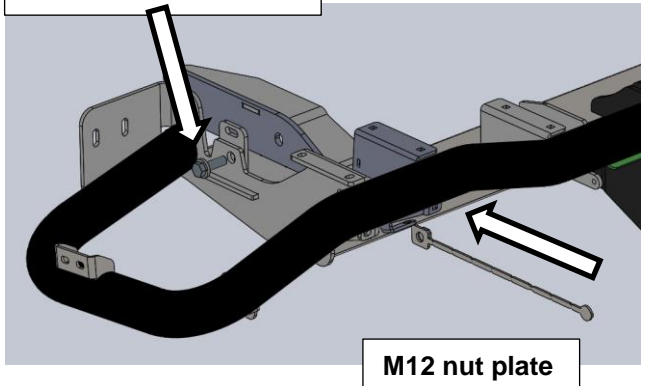

M12 nut plate



40. With the rear bar fitted. Mark and drill 1 x Ø13mm hole on the bottom face of both chassis rails.
41. Add anti-corrosion touch up paint to area drilled.



**WARNING:** Drilling & cutting operations can result in flying debris. Eye and ear safety protection should be worn.

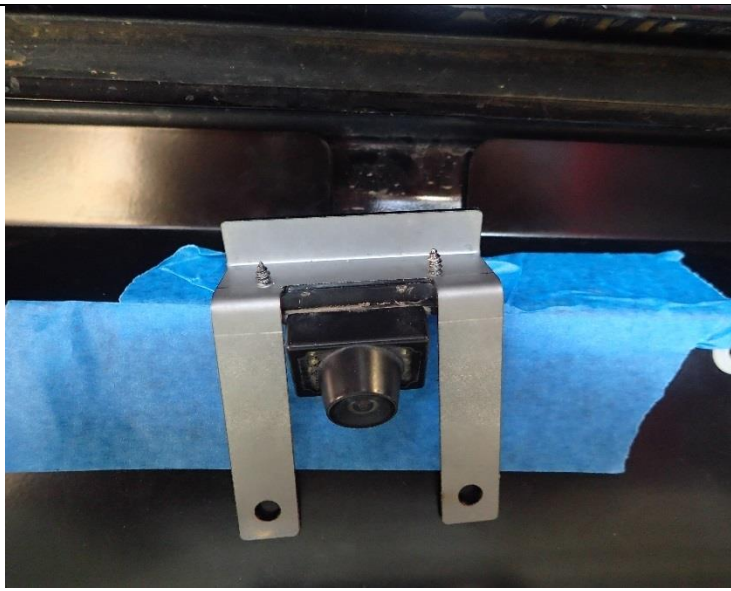

42. If fitted with Reverse parking camera fix camera to bracket supplied with existing fasteners

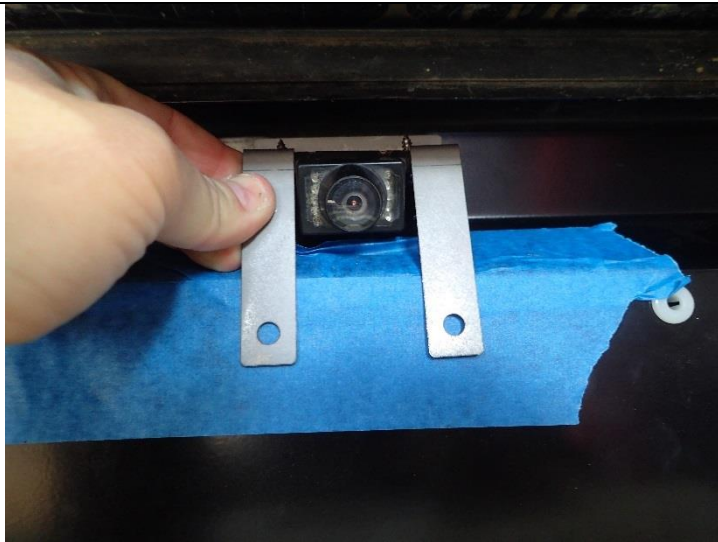

43. Position camera and bracket on the Beaver panel. Check function of the camera, when the camera is positioned correctly make and drill 2 x Ø7.0 mm holes. Secure camera and bracket to the beaver panel with 2 x M6 cap head screws, washers and nuts.



**WARNING: Drilling & cutting operations can result in flying debris. Eye and ear safety protection should be worn.**



M6 X 1.0 - 9 Nm.



## RSTB TO VEHICLE



44. Install Beaver Panel. Insert 4 x M6X20 bolt and washer through beaver panel and position spacer as shown

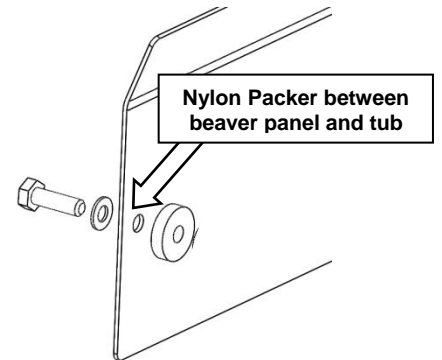

M6 X 1.0 - 9 Nm.

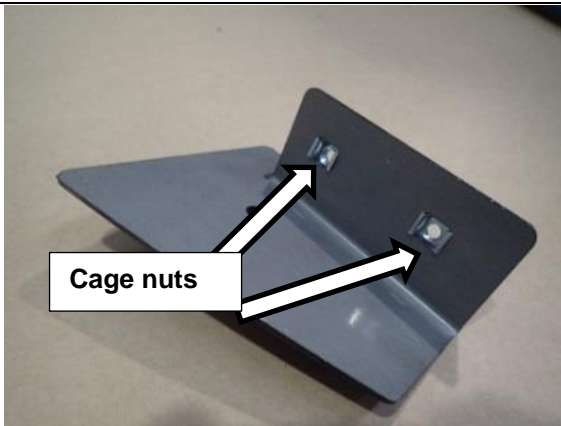

45. Fit 2 cage nuts to beaver panel bracket for both RH and LH parts. (as shown)

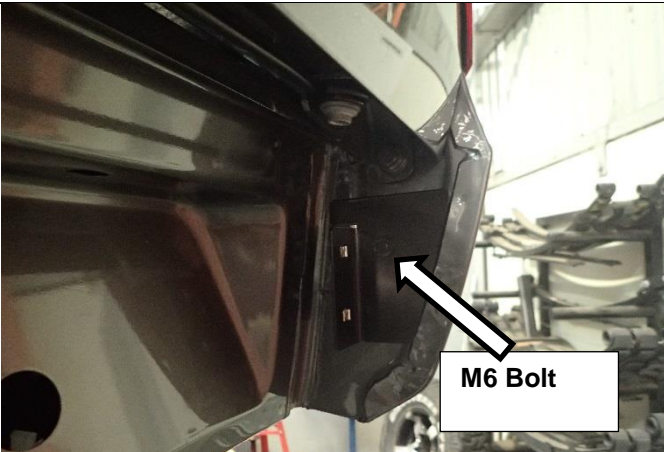

46. Fit bracket with a M6 nut, bolt and flat washer to body. (Beaver Panel removed for clarity)



M6X 1.0 - 9 Nm.

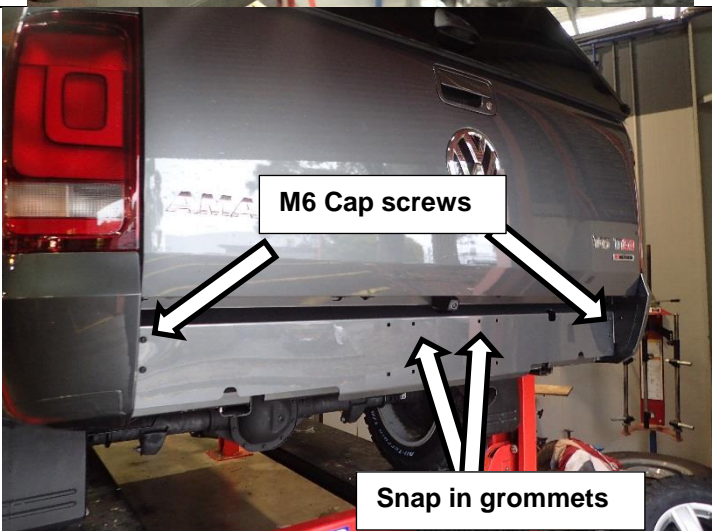

47. Fit 4 x M6 cap head screws and washers to fix beaver panel to beaver panel bracket

48. Fit the 4 plastic snap in grommets in holes provided and fit licence plate with screws provided.



M6 X 1.0 - 9 Nm.



## RSTB TO VEHICLE



49. With the assistance of other people or a lifting device, lift the RSTB up beneath the chassis rails aligning the threaded holes in the side of the chassis with those in the vertical surfaces of the RSTB.

**Note: Take care to ensure the trailer plug wiring is not damaged during this step.**

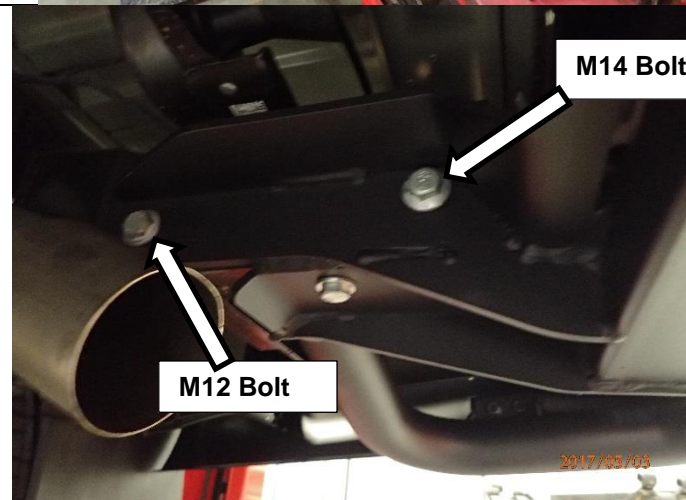

50. Fix the RSTB to the threaded holes in each chassis rail using 1 M12 x 1.25x40 (fine pitch) hex head bolt, 1 M14 x 110 bolt and nut. Leave finger tight at this stage.

**Note: When fitting RSTB to MY11-15 vehicles fit 2 x M12 bolts per side on inside of rail, 1 x M12 bolt and nut plate on outer side of chassis rail, refer step 37-39**

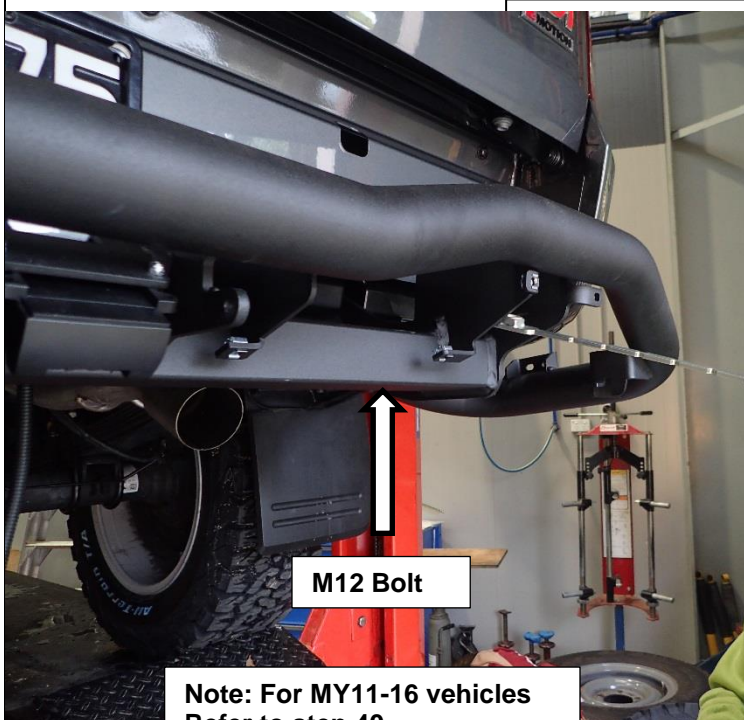

51. Insert M10 nut plate in chassis and fasten with M10 x 1.5 bolt and flat washer. Insert the spacer on the outside of both chassis rails or the rear M14 Bolt as shown below.
52. Check RSTB spacing to vehicle and tighten all fasteners to the specified torque.

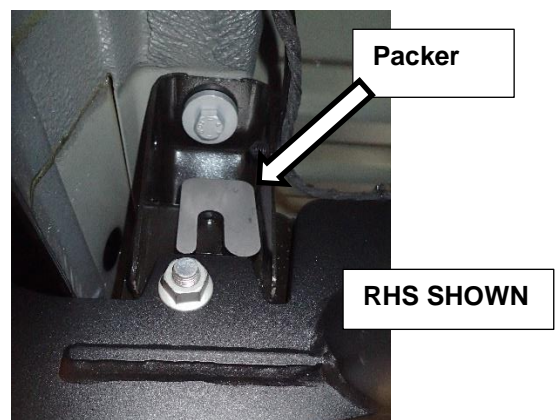

M10 x 1.5 – 44 Nm.

M12 X 1.25 - 95 Nm.

M14 x 1.5 – 185 Nm.

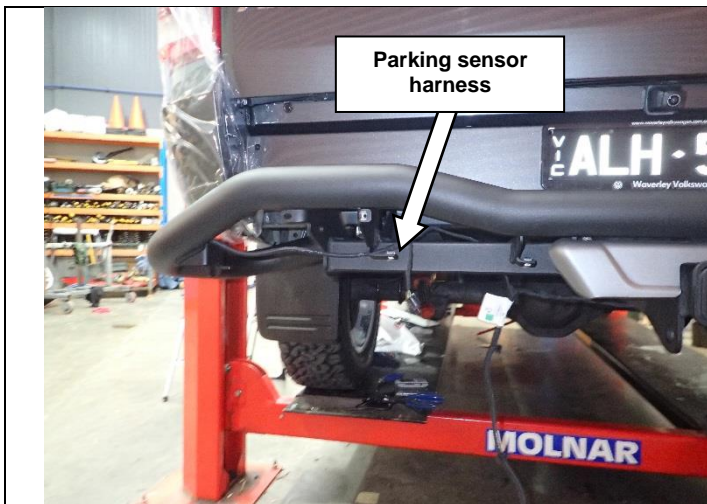

53. Route the trailer plug loom and parking sensor loom through the RSTB and attach to the appropriate connector on the RSTB wiring harness or vehicle loom as shown.
54. Ensure all trailer tail lights function normally.

**Note: Test that the trailer park, brake and reverse lights function normally. Also test the left and right indicators along with the hazard setting.**

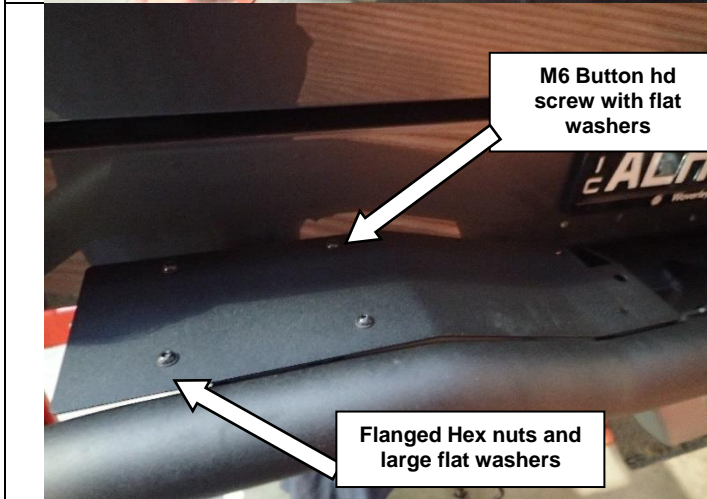

55. Attach the 2 step plates to the RSTB using 4 black M6x1.0x16 button head screws and washers for both right and left hand sides. The 2 outer screws require flanged hex nuts and large flat washers.

 M6 X 1.0 - 9 Nm.

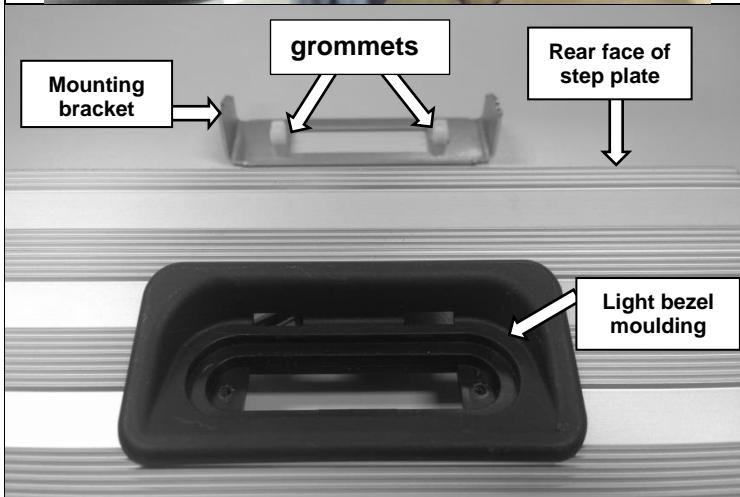

56. Push 2 plastic snap-in small grommets through the 2 holes in the LED mounting bracket as shown. Install the grommets from the underside of the bracket.

57. Fit the light bezel moulding to the step plate extrusion as shown with the deep section facing towards the rear face of step plate.

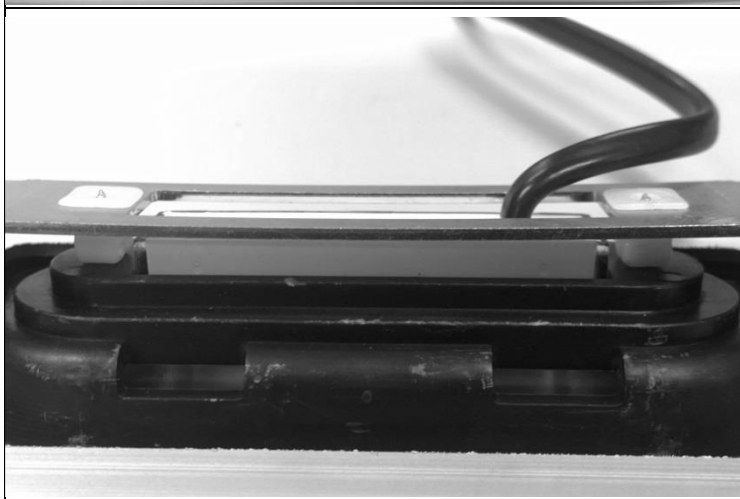

58. **Remove the foam ring from the LED lamp and discard.**
59. Place the LED lamp in the light bezel moulding and fix to the mounting bracket using the screws supplied in the lamp kit.

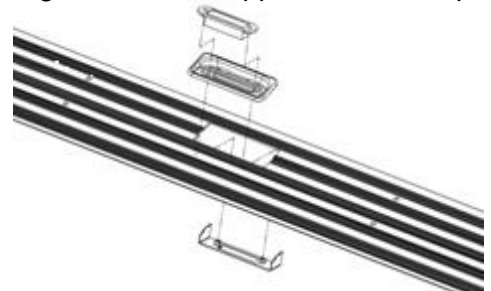



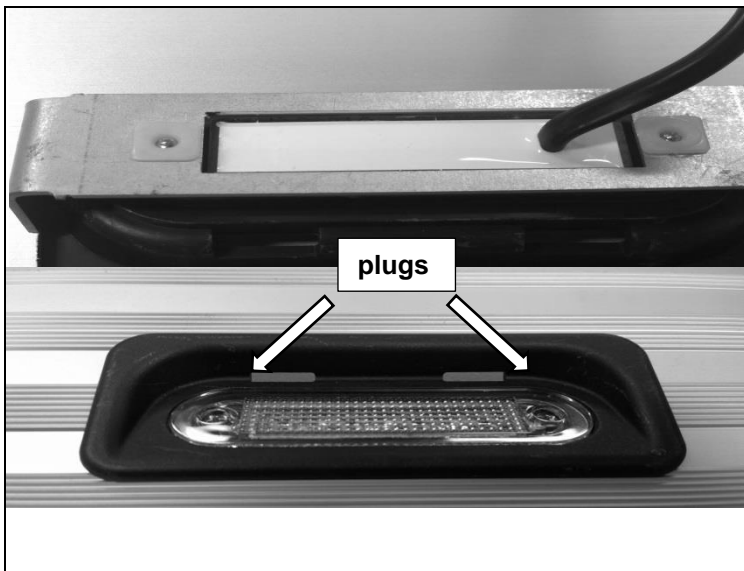

60. Fit the clear plastic plugs supplied in the lamp kit to the LED lamp above the screws.

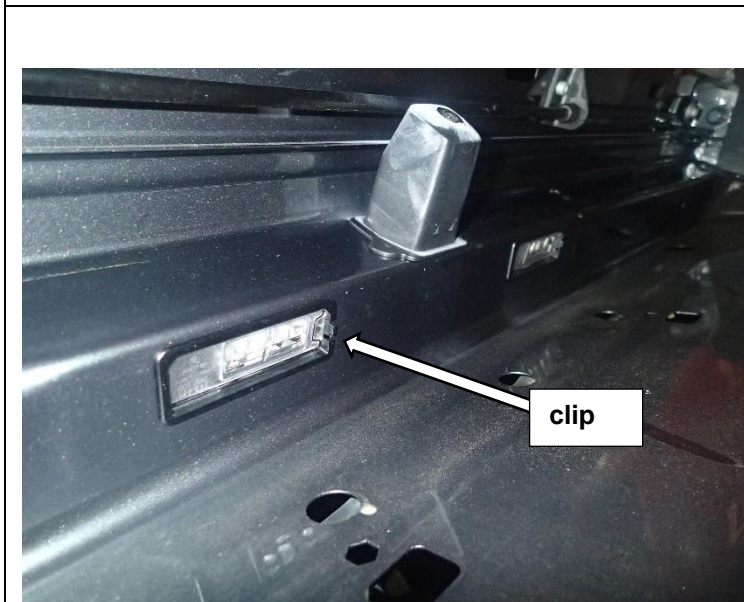

61. Remove the vehicle licence plate lights and disconnect the them from the harness.
62. Cut licence plate loom at branch point and remove 10mm of the plastic insulation coating from the license plate lamp loom.
63. Insert a 30mm piece of heat shrink over each wire as shown.

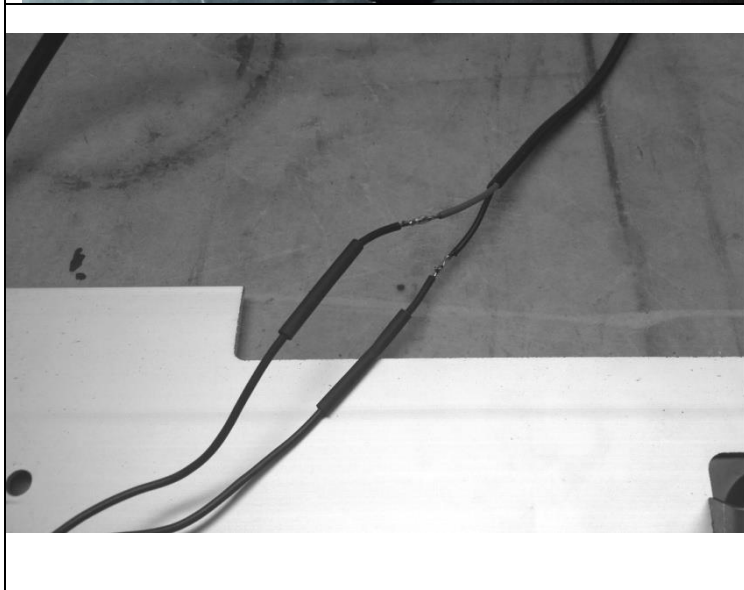

64. Using a soldering iron and solder, join the LED lamp wires to the license plate lamp or sensor loom use a multimeter to verify positive and negative wire

***Note: The LED lamp is polarity sensitive so it is important to identify and solder the correct wires together.***



65. Place the heat shrink over the soldered wires and use a heat gun to shrink in place.
66. Further protect each join with corrugated tubing and insulation tape.

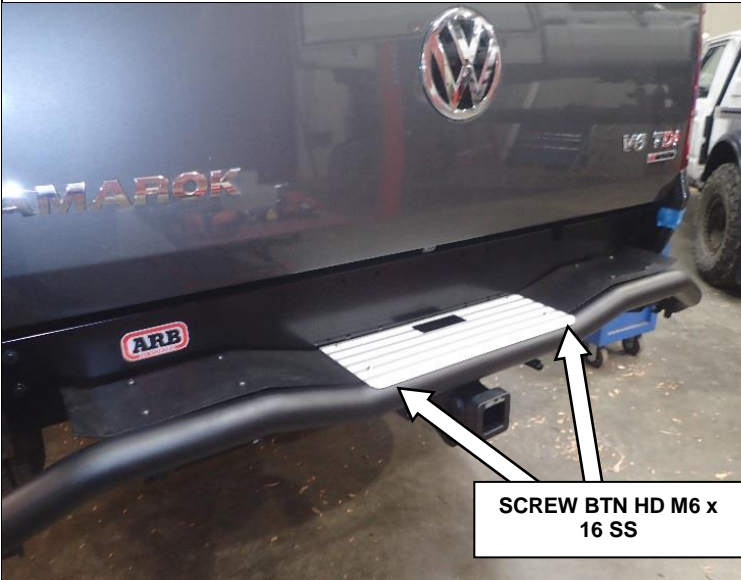

67. Attach the step plate extrusion to the RSTB using 4 x stainless steel M6x1.0x16 button head screws.

**NOTE: Do not install washers under the 8 M6 button head screws that are fixing the step plate extrusion to the RSTB**



M6 X 1.0 - 9 Nm.



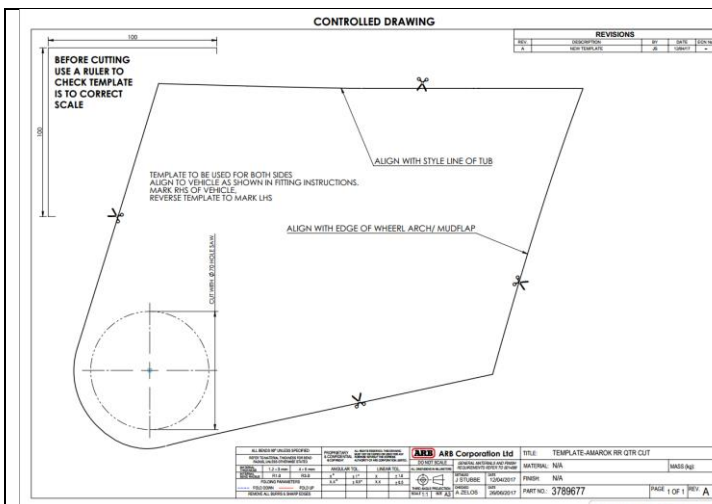

68. Using scissors carefully cut out the supplied paper template.

**Note: This Template will be used for both LH and RH sides; be careful not to damage it.**

**CAUTION: CHECK SCALE OF TEMPLATE BEFORE USE.**

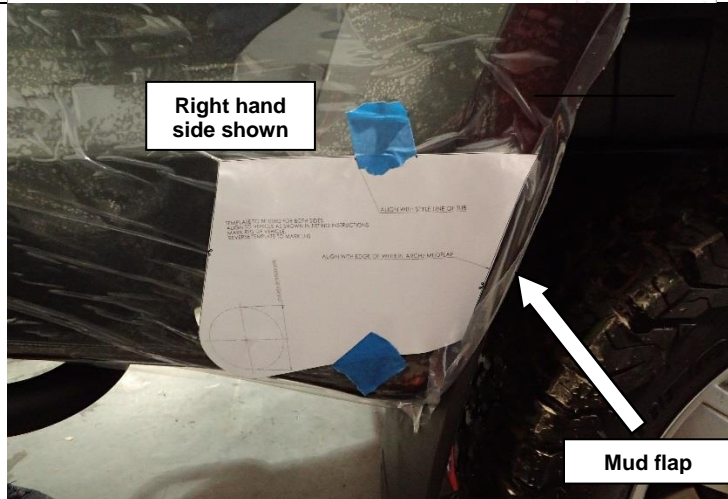

69. Place the cutting template on the right hand rear side panel of the tub aligning it with the wheel arch edge of tub and bottom edge of the tub. Use masking tape to hold in place.

70. Mark the centre of the cutting hole on the rear side panel and then remove the template.



71. Using a  $\varnothing 70$ mm hole saw, drill through the rear side panel using the mark from the previous step as the centre point of the hole.



72. Repeat steps 63 to 65 for the left hand rear side panel using the opposite side of the template.



73. De-bur each hole to remove sharp edges.

74. Treat raw edges with a rust preventative paint.

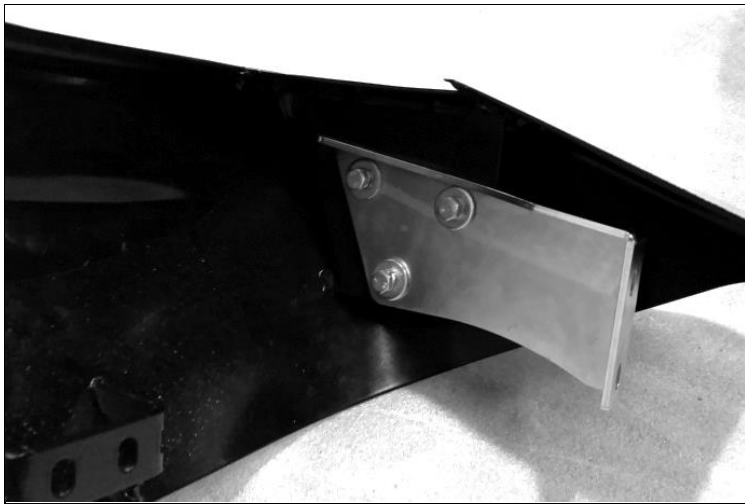

75. Fix a wing mount bracket to each wing using 3 M8x1.25x25 hex head bolts and a wing triple nut plate. Orientate each bracket as shown. Leave bolts finger tight at this stage.

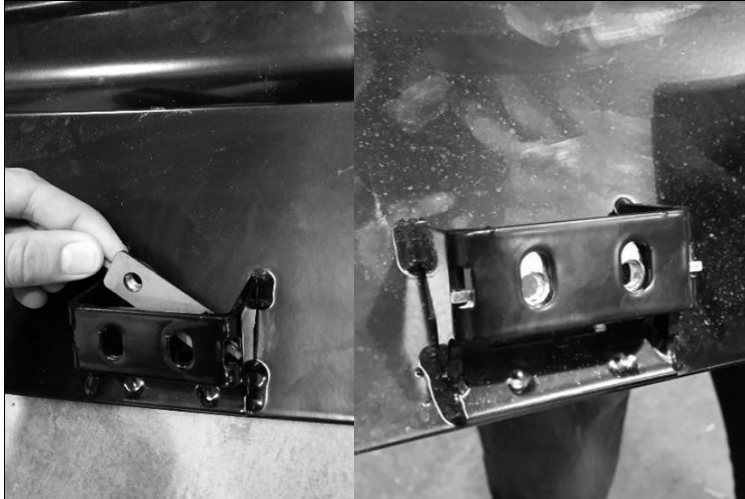
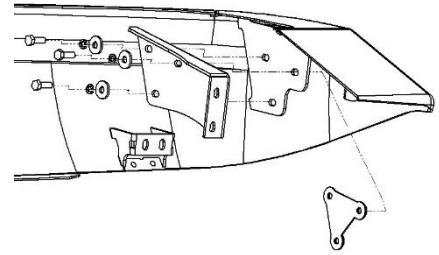

76. Place a wing double nut plate inside the middle bracket of each wing as shown.

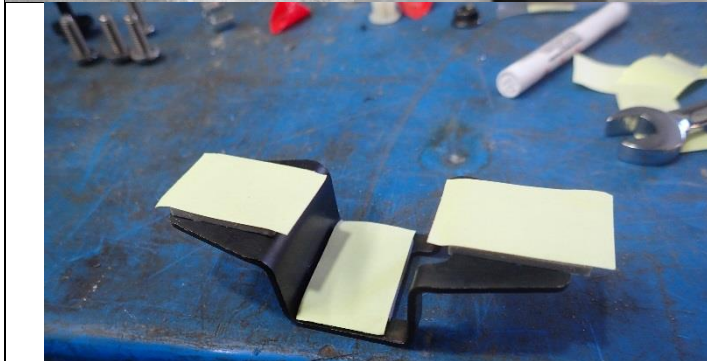

**Note:** Ensure the parking sensor bracket is clean and free of residual tape and foreign matter.

77. Prepare for fitting parking sensors to the rear wings and diffusers by applying the 2 layers of 3M double sided tape Parking sensor bracket as shown.



78. Prior to fitting wings to the vehicle, fit the sensor and bracket to the wing assembly and then connect the harness.

**Note:** Ensure both the parking sensor bracket and mating area of the Rear Bar wing are clean and free of residual tape and foreign matter.

When installing the bracket and sensor ensure the sensor is central in hole and not pressed to one side

Ensure sensor installed in the correct orientation.

Ensuring the clear silicone grommet remains on sensor.







79. With the assistance of other people fit the rear parking sensor and bracket to the wing and fit the wing to the centre mount using 2 X M8x1.25x25 hex head bolts and nuts.

Do not fully tighten at this stage.

***Apply masking tape to tub to eliminate any damage to paintwork when positioning wing***



80. With the assistance of other people or a lifting device, position the wings next to the rear side vehicle panels. Take care not to damage the vehicle when positioning the wings.

Right wing mount bracket shown

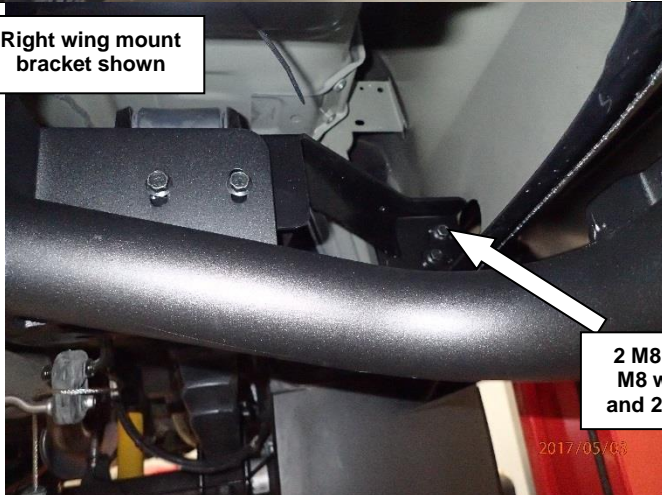

2 M8 bolts, 4 M8 washers and 2 M8 nuts

81. Pass the front bracket of each wing through the Ø70mm hole in the tub and fasten to the wing mount strut using 2 M8 hex head bolts, 2 X M8 nuts. Do not fully tighten at this stage.



82. Fix the wing mount bracket of each wing to the RSTB using 2 X M8x1.25x25 hex head bolts, 4 M8 flat washers and 2 X M8 nuts. Do not fully tighten at this stage.



83. Fix the middle bracket of each wing to the RSTB tube using 2 X M8x1.25x20 hex head flanged bolts and the wing double nut plate already fitted. Leave bolts finger tight at this stage.



84. Position each wing so there is an even 10-12 mm gap to the side vehicle panels.



85. Position each wing so they there is an even gap to the mud flap as shown.



86. Position each wing so they sit evenly on the step plate and there is an even gap to the tube as shown.





87. Tighten all 6 X M8 bolts that retain each wing to the specified torque.

 M8 X 1.25 - 22 Nm.

**Note: Check that all clearances are maintained as the fasteners are tightened.**

Right diffuser panel shown



88. Attach the rear parking sensor with 3M double sided tape to the diffuser panel, ensure the sensor is centre in the hole.

**Note: Ensure both the parking sensor bracket and mating area of the Diffusers are clean and free of residual tape and foreign matter.**

**When installing the bracket and sensor ensure the sensor is central in hole and not pressed to one side**

**Ensure sensor installed in the correct orientation.**

**Ensuring the clear silicone grommet remains on sensor.**



89. Attach the diffuser panels to the RSTB using 8 X M6x16 button head screws and M6 stainless flat washers. For the outer most screw on each panel, a M6 nut is required to fix to the RSTB. The lower outer fixings use 2 X M6X 20 hex head bolts, M6x19 black washer and M6x12 black washer and M6 nyloc nut as shown.

 M6 X 1.0 - 9 Nm.

Outside face- M6X20 Hex head bolt and M6x19 black washer.  
Inside face - M6 X12 black washer and M6 nyloc nut

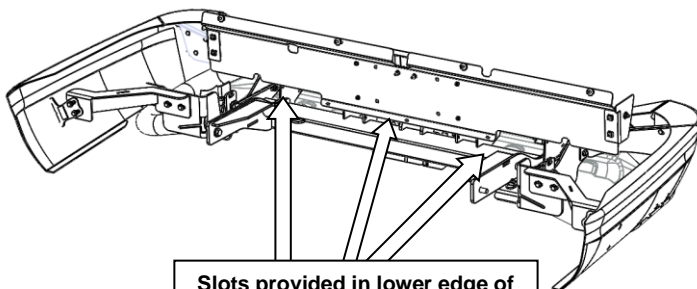

Slots provided in lower edge of beaver panel and RSTB frame brackets

90. Tidy and fasten all wiring using cable ties and the slots in the RSTB brackets, as well as existing fastening locations.

**Warning: Make sure all wires are securely fastened away from any hot, sharp or moving surfaces. Do not fasten wiring harness to fuel or brake lines.**

91. Ensure trailer tail lights function normally as per step 22.



Even gap along these edges

92. Position each diffuser panel so there is an even gap between the panel and the RSTB tube. Tighten fasteners to the specified torque.

 M6 X 1 -9 Nm.



93. Reattach the spare wheel beneath the vehicle. Store tow tongue, pull pin and R-clip in a safe and secure location when not in use.

#### ONCE BAR IS FITTED:

- ◆ Ensure all bolts are tensioned correctly.
- ◆ Ensure all wiring is clear of sharp edges or moving surfaces and secured properly.
- ◆ Piping is secured well away from sharp or moving components
- ◆ Test operation of parking sensors after fitment.
- ◆ Check all wiring and connections to turn signal lamps, sensors, headlamp washers etc. are functioning correctly
- ◆ Misalignment of sensor to hole in bull bar may cause malfunction.
- ◆ Do not paint over sensor.

#### Note:

Do not add any accessories to the Rear Bar on or around the sensors, this may affect the function of the sensors.

Sensors may not function well under the following conditions;

- ◆ After the vehicle, has been sitting out in hot or cold weather.
- ◆ When the system is affected by electrical equipment or devices generating an ultrasonic wave.
- ◆ When operating in bad weather



## FITTED PRODUCT





# FITTED PRODUCT



TRAILER CAMERA PLUG, ANDERSON PLUG AND AIR-LINE FITTING



TRAILER PLUG



HIGH LIFT JACK LOCATION - CORNER OF RSTB

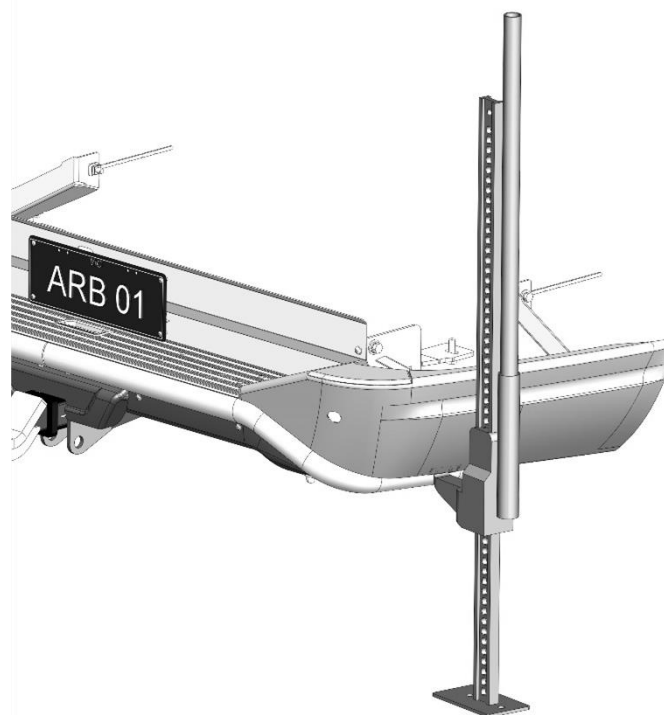

HIGH LIFT JACK LOCATION - SIDE OF WING/ABOVE TUBE

